

KINGSTON BRASS Undermount Lavatory LB24157

Installation Instructions :

1. Cut the template on the dotted line.
2. Place the outer portion in the exact location that the sink is to be installed.
Check for clearance between the lavatory , faucet , backsplash and cabinet.
Adjust if necessary.
3. Trace the template on the countertop.
4. Cut out the opening along the inside edge of the line that was drawn
and install per the instructions.
5. Install the fittings and drain assembly per instructions supplied
by manufacturer.
6. Apply sealant (not supplied) to basin rim.
7. Install sink and caulk around perimeter.
8. Carefully remove all excess sealant and caulk from both the countertop
and the basin rim with a damp cloth.
9. Connect water supplies and check for leaks.

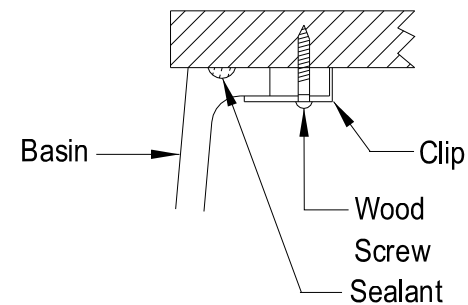
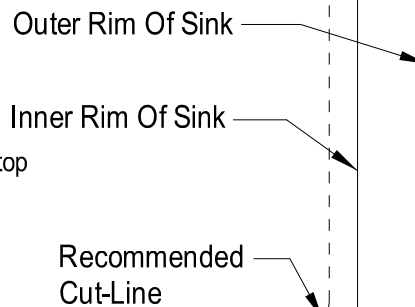

Detail for Wood Countertop

For Insert : Drill 3/8" dia.
hole 1/2" deep.

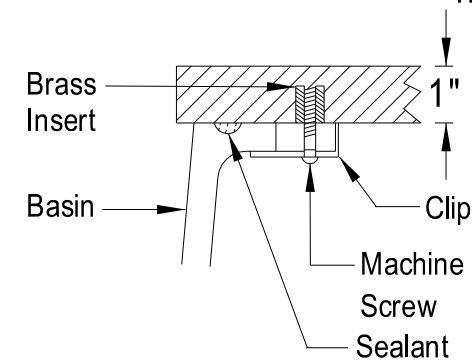

Detail for Solid Countertop