

10 YEAR MANUFACTURER'S LIMITED WARRANTY

All parts of this Kingston Brass faucet are warranted to the original retail purchaser to be free from defects in material and workmanship for a period of Ten(10) years from the date of purchase as shown on the purchaser's receipt.

This warranty is limited to defective parts only, labor charges and/or damage resulting from improper installation, repair or replacements, as well as incidental and consequential damages connected therewith are excluded.

Any damage to this faucet as a result of misuse, abuse, neglect, accident, or improper installation or any use not consistent with the instructions furnished by us, will void this warranty. Replacement parts can be obtained from your local dealer. Freight cost is not covered by manufacturer.

CAUTION!!!

1. Water lines must be completely flushed before use, to avoid debris & clogs in your water system leading to reduction of water flow and mal-functioning.
2. Warranty is void if water lines are not flushed prior to use and installation of the new faucet.
3. Use of abrasives of any strength may damage the finish of the faucet and void the product warranty.
4. Do not over tighten your faucet on the countertop during installation. The valve assembly is tested to meet the standards set by ASME A112.18.1 sec 5.8 which is listed at 100 LBF. However, over-tightened or over-torqued nuts may lead to cracks on the valve and will eventually lead to leaking and water damage.
5. Before installation of the faucet to the desired fixture, you need to secure and anchor your console, sink, tub, or vanity cabinet firmly to the wall and to the floor. To ensure your fixture or faucet mounting surface cannot be moved, before installation of the faucet, please test to see if the cabinet or vanity can be moved by hand or body weight. If the faucet mounting fixture is not secure and anchored, it will eventually crack the valve and cause leaking leading to property damage. In order to avoid this, be sure to secure your installation surface. Do not use any Power Tools for assembly and installation which can cause internal fractures to the fixture.

KINGSTON

KITCHEN & BATH

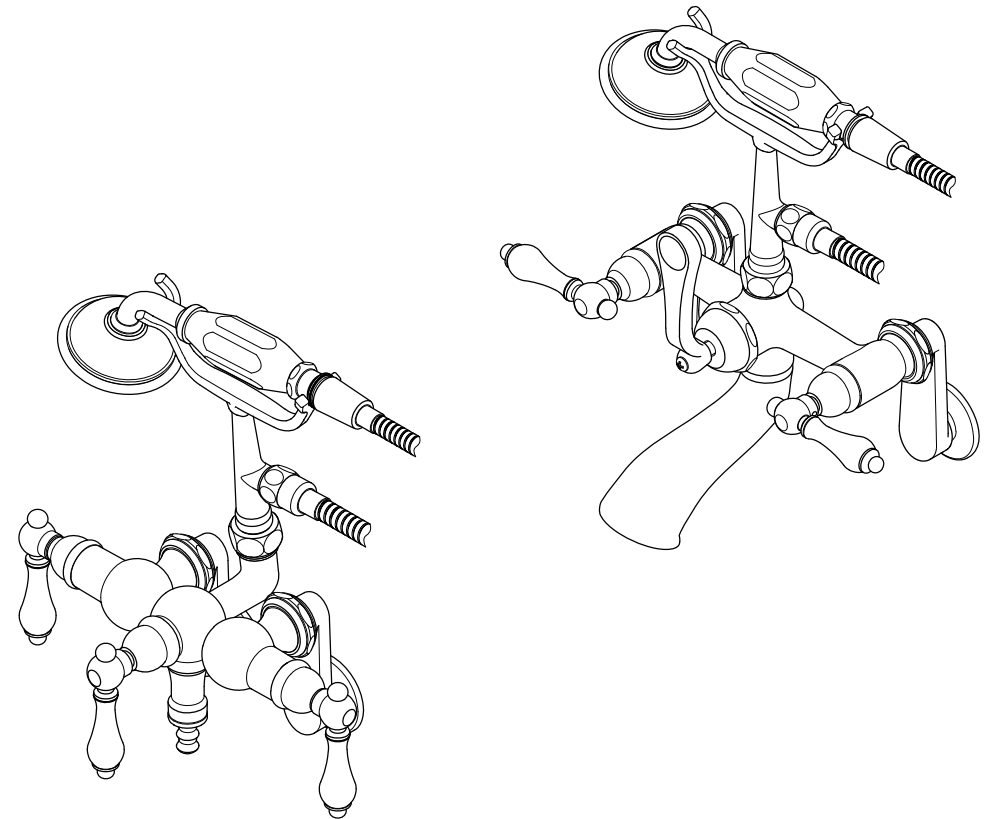

PROBLEMS SHOOTING

PROBLEM	CAUSE	CORRECTIVE ACTION
Leaks underneath handle	Bonnet nut has come loose	Remove the handle and tighten the bonnet nut
Leaks from the spout	Valve seat and spring are worn	Replace the valve seat and spring
Inconsistent water flow pattern	Aerator is dirty or aged	Release aerator and check on rubber gasket if aged or replace with a new aerator
Faucet is dirty	Caused by stubborn water spot	Clean with mild soap and warm water as often as possible
Handles work backward	Handle installed backward	Rotate the right stem stop assembly 180 degrees

Parts:

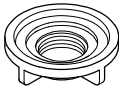
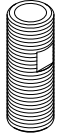
Lock Nut	Copper Shank
	
2 Pcs	2 Pcs

www.kingstonbrass.com

TOLL-FREE CUSTOMER SERVICE: 1-877-2-KBRASS

TECHNICAL SUPPORT E-mail: service@kingstonbrass.com

12775 Reservoir Street, Chino, CA 91710

CODE APPROVAL: LA#M-000018

KINGSTON

KITCHEN & BATH

INSTALLATION INSTRUCTIONS Wall Mount Tub Filler with Hand Shower

BEFORE BEGINNING INSTALLATION:

1. Flush plumbing lines to clear any debris.
2. Shut off both supply lines after flushing.

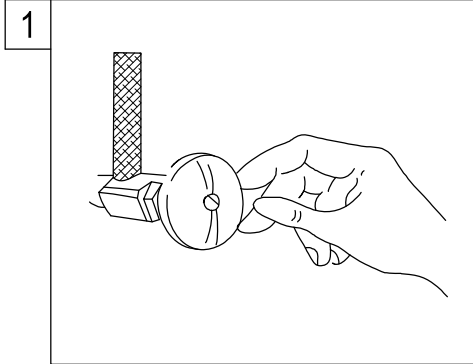

1. Shut off main water supply valve before installation.

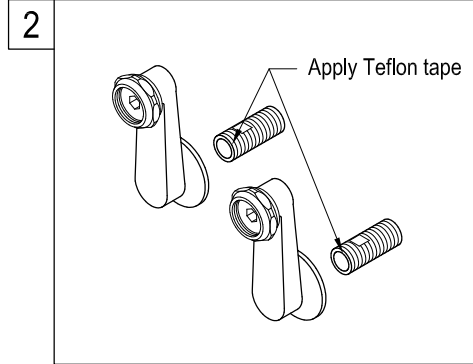

2. Apply Teflon tape on the threads of the copper shanks. Install the elbow.

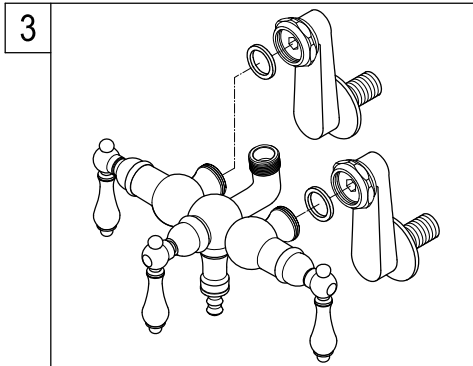

3. Before mounting the faucet onto supply elbows, apply small black washers onto both water inlets of faucet.

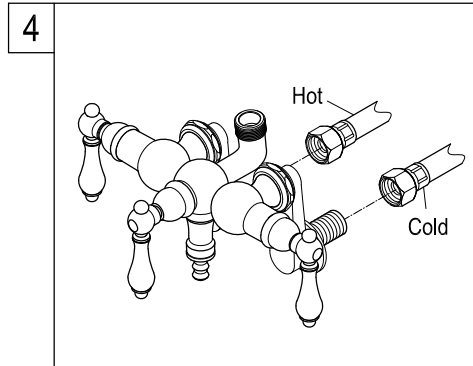

4. Connect water supply shank to hot and cold water supply line.

Need Tools:



Basin Wrench



Adjustable Wrench



Teflon Tape



Silicone Sealant



Screwdriver

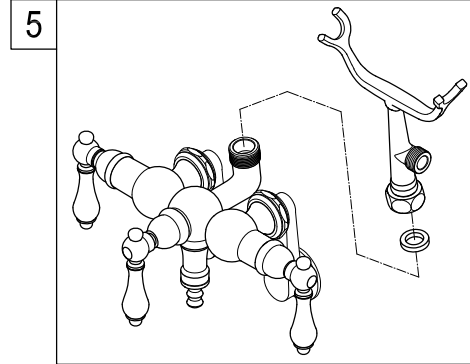

5. Install the shower cradle on top of faucet body.

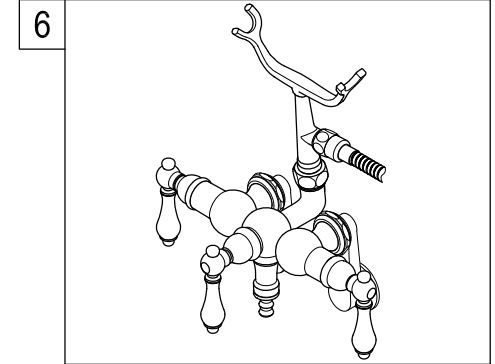

6. Place a washer between the side hole of the shower cradle and the cone nut of the shower hose. Tighten the cone nut.

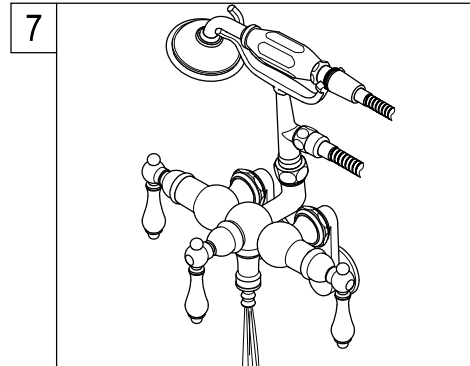

7. Turn on the faucet and let hot and cold water to run for at least one minutes to clean any debris inside the water line.

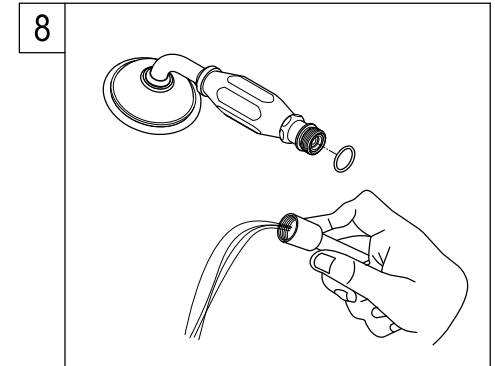

8. Remove shower by unscrewing the shower in a counter clockwise direction, turn on both hot and cold valves and let water run for at least one minute, this will clear any debris left in the line.

Warning!!!

- **DO NOT STEP ON faucet or supply line installation.** This fixture is not a stair to access your storage, window or access higher ceiling. This Cast Brass Faucet cannot support your body weight. To step on faucet will crack the fitting and eventual fracture to cause water damage to your property.
- The faucet was tested and meets ASME/ANSI code on its operation, loading and torque pressure. However this faucet is not designed to support weight over 250 pound per square inch of pressure, **DO NOT OVERTIGHTEN.** **DO NOT APPLY ELECTRICAL TOOL** to fasten faucet installation.
- For Exposed tub supply line installation faucet model, your supply lines have to be installed on corner area, or at area with no walking traffic access to cause accidental tamper or accidental breakage. For installation of exposed supply line at open traffic area is prohibited.
- Removal of this tag prior to installation will void your warranty. Pass the WARNING TAG to the owner after installation.



KINGSTON

KITCHEN & BATH

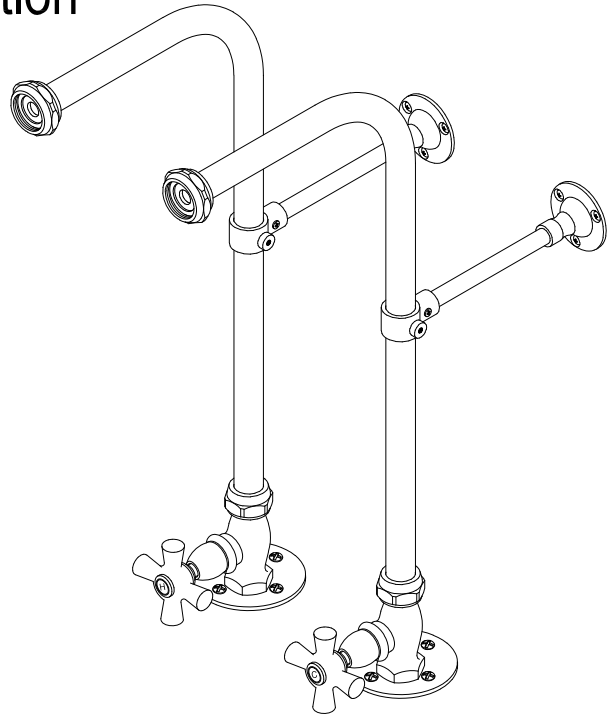
Free standing supply lines Installation

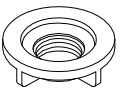
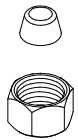
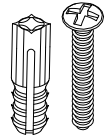

Parts:

Lock Nut	Cone Washer & Coupling Nut	Screw & Anchor	Screw & Set Screw
			
2 Pcs	2 Pcs	14 Pcs	2 Pcs

www.kingstonbrass.com
 TOLL-FREE CUSTOMER SERVICE: 1-877-2-KBRASS
 TECHNICAL SUPPORT E-mail: service@kingstonbrass.com
 12775 Reservoir Street, Chino, CA 91710

Before starting the installation of your supply lines you should:

- Verify the center to center of your faucet and rough in your supply lines accordingly.
- Measure the distance from the finished floor to the top of the tub rim where your faucet will be installed, if the distance is higher than 23" then you will need to purchase item number CC451EXT, which will add 7" to the height.
- Measure the distance from where your supply lines will be installed to the wall, if you are more than 13-3/4" away from the wall, you will need to purchase item number CC431, this set of 2 drain bracelets will help you secure your free standing supply lines to the vertical pipe on the waste & overflow.

Installation Steps:

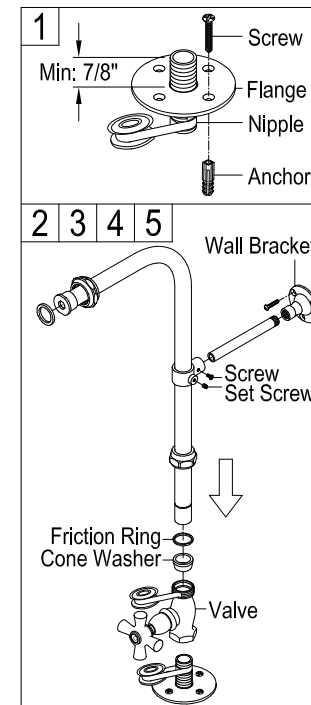

1. After applying Teflon tape, thread 1/2" brass nipple to your supply pipe, make sure that nipple protrudes from the finished floor a minimum of 7/8", thread floor flanges onto brass nipple until it meets the finished floor, secure using attached stainless screws and anchors.
2. Apply Teflon tape to threads on brass nipple and attach shut off valves or extension, if you do use an extension apply Teflon tape to the top threads, then attach shut off valve.
3. Insert wall support ring, nut, friction ring and cone washer onto supply line, apply Teflon tape to shut off valve, insert supply line and tighten nut.
4. Measure distance from the wall to the supply line, after inserting support rod into wall bracket, cut to the desired length, insert into wall support ring and fasten using set screws, be careful not to over tighten set screw securing the ring to the supply line as it may dent or puncture the supply line.
5. Turn on supply lines and check for leaks.

If the distance is more than 13-3/4" from the supply line to the wall.

1. Insert drain bracelets into the overflow tube
2. Thread support rod onto drain bracelet, measure distance to supply line and cut accordingly, insert into support ring installed on supply line and secure by tightening set screws, be careful not to over tighten set screw securing the ring to the supply line as it may dent or puncture the supply line.

Warning!!!

Reshaping, bending or altering supply line except for cutting to size Or use of nuts or washers not supplied with this kit will void your warranty.
 Supply lines are designed to be braced to the wall or the overflow tube, Failure to secure properly will void the warranty.
 Please do not pull or lean on the faucet once it has been installed, this may bend or pull the supply line which may cause a leak resulting in possible water damage.

Installer:

Please pass this label on to homeowner after installation.