

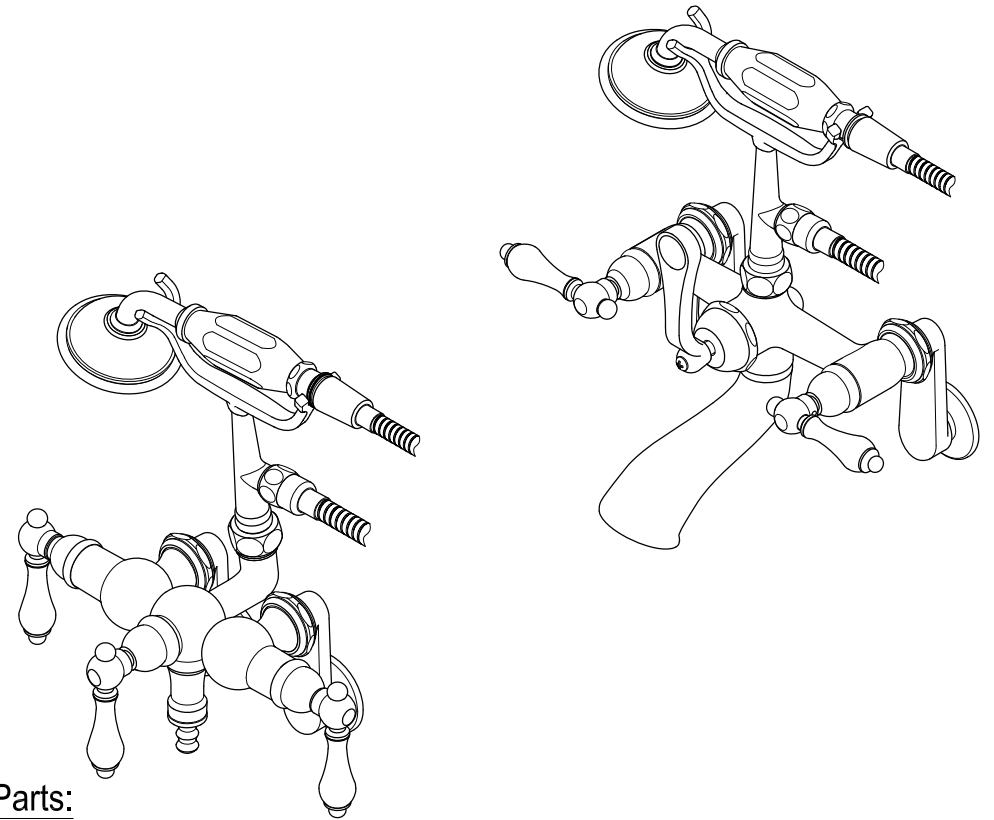

# KINGSTON

KITCHEN & BATH

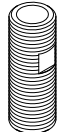

## Parts:

Lock Nut	Copper Shank
	
2 Pcs	2 Pcs

[www.kingstonbrass.com](http://www.kingstonbrass.com)

TOLL-FREE CUSTOMER SERVICE: 1-877-2-KBRASS

TECHNICAL SUPPORT E-mail: [service@kingstonbrass.com](mailto:service@kingstonbrass.com)

12775 Reservoir Street, Chino, CA 91710

## NOTICE

Failure to follow all directions may cause leaks  
which may result in water damage

## CAUTION

Failure to follow all installation directions may  
cause product to detach from the wall and  
cause serious injury

# KINGSTON

KITCHEN & BATH

## INSTALLATION INSTRUCTIONS Wall Mount Tub Filler with Hand Shower

### BEFORE BEGINNING INSTALLATION:

1. Flush plumbing lines to clear any debris.
2. Shut off both supply lines after flushing.

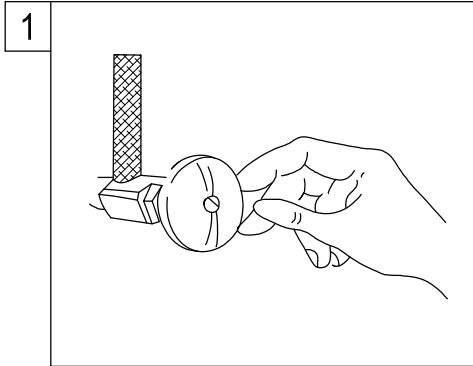

1. Shut off main water supply valve before installation.

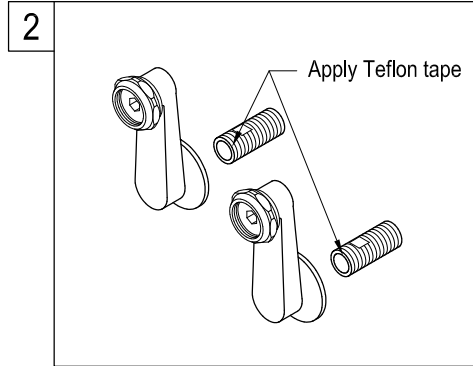

2. Apply Teflon tape on the threads of the copper shanks. Install the elbow.

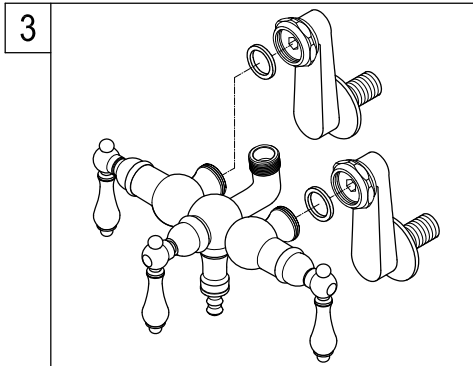

3. Before mounting the faucet onto supply elbows, apply small black washers onto both water inlets of faucet.

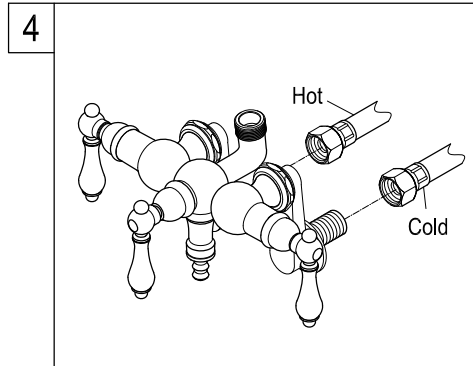

4. Connect water supply shank to hot and cold water supply line.

### Need Tools:

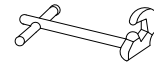

Basin Wrench



Adjustable Wrench



Teflon Tape

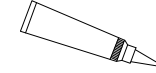

Silicone Sealant

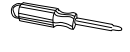

Screwdriver

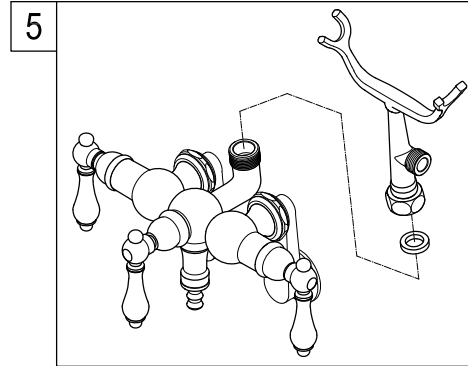

5. Install the shower cradle on top of faucet body.

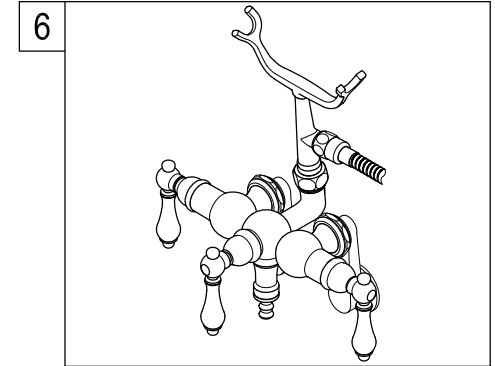

6. Place a washer between the side hole of the shower cradle and the cone nut of the shower hose. Tighten the cone nut.

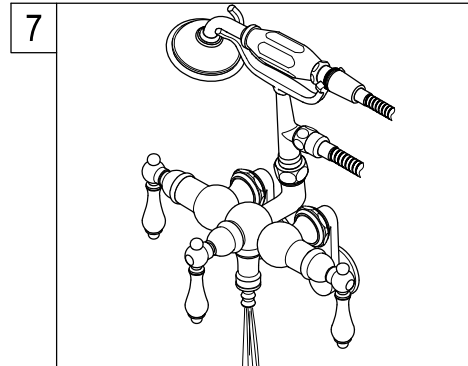

7. Turn on the faucet and let hot and cold water to run for at least one minutes to clean any debris inside the water line.

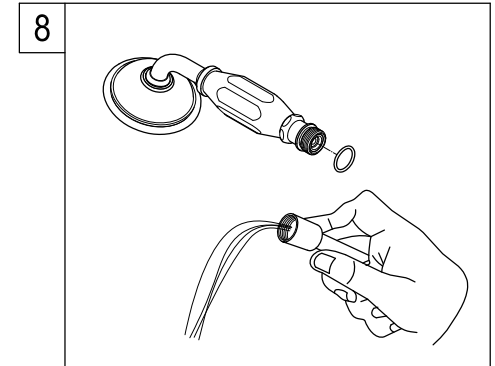

8. Remove shower by unscrewing the shower in a counter clockwise direction, turn on both hot and cold valves and let water run for at least one minute, this will clear any debris left in the line.

### Warning!!!

- **DO NOT STEP ON faucet or supply line installation.** This fixture is not a stair to access your storage, window or access higher ceiling. This Cast Brass Faucet cannot support your body weight. To step on faucet will crack the fitting and eventual fracture to cause water damage to your property.
- The faucet was tested and meets ASME/ANSI code on its operation, loading and torque pressure. However this faucet is not designed to support weight over 250 pound per square inch of pressure, **DO NOT OVERTIGHTEN.** **DO NOT APPLY ELECTRICAL TOOL** to fasten faucet installation.
- For Exposed tub supply line installation faucet model, your supply lines have to be installed on corner area, or at area with no walking traffic access to cause accidental tamper or accidental breakage. For installation of exposed supply line at open traffic area is prohibited.
- Removal of this tag prior to installation will void your warranty. Pass the WARNING TAG to the owner after installation.

# KINGSTON

KITCHEN & BATH

## INSTALLATION INSTRUCTIONS



### Shower Riser Bath Supply

#### BEFORE BEGINNING INSTALLATION:

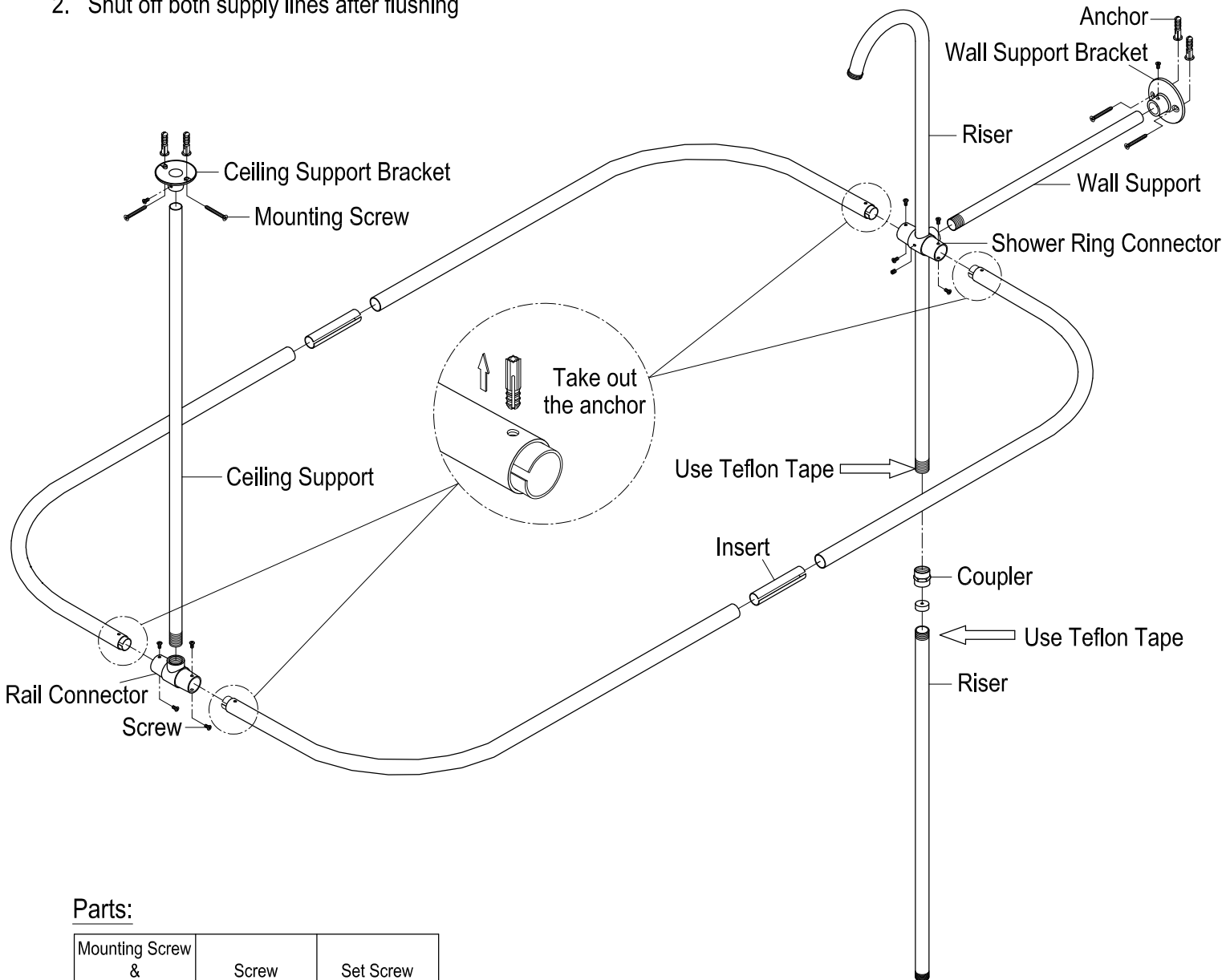
1. Flush plumbing lines to clear debris in pipe and plumbing lines to avoid existing clogs into waterway & cartridge system of new faucet fixture.
2. Shut off both supply lines after flushing

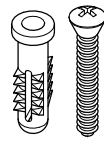

#### Parts:

Mounting Screw & Anchor	Screw	Set Screw
		
4 Pcs	10 Pcs	1 Pc

www.kingstonbrass.com  
 TOLL-FREE CUSTOMER SERVICE: 1-877-2-KBRASS  
 TECHNICAL SUPPORT E-mail: service@kingstonbrass.com  
 12775 Reservoir Street, Chino, CA 91710

## NOTICE

Failure to follow all directions may cause leaks which may result in water damage

## CAUTION

Failure to follow all installation directions may cause product to detach from the wall and cause serious injury

# KINGSTON

KITCHEN & BATH

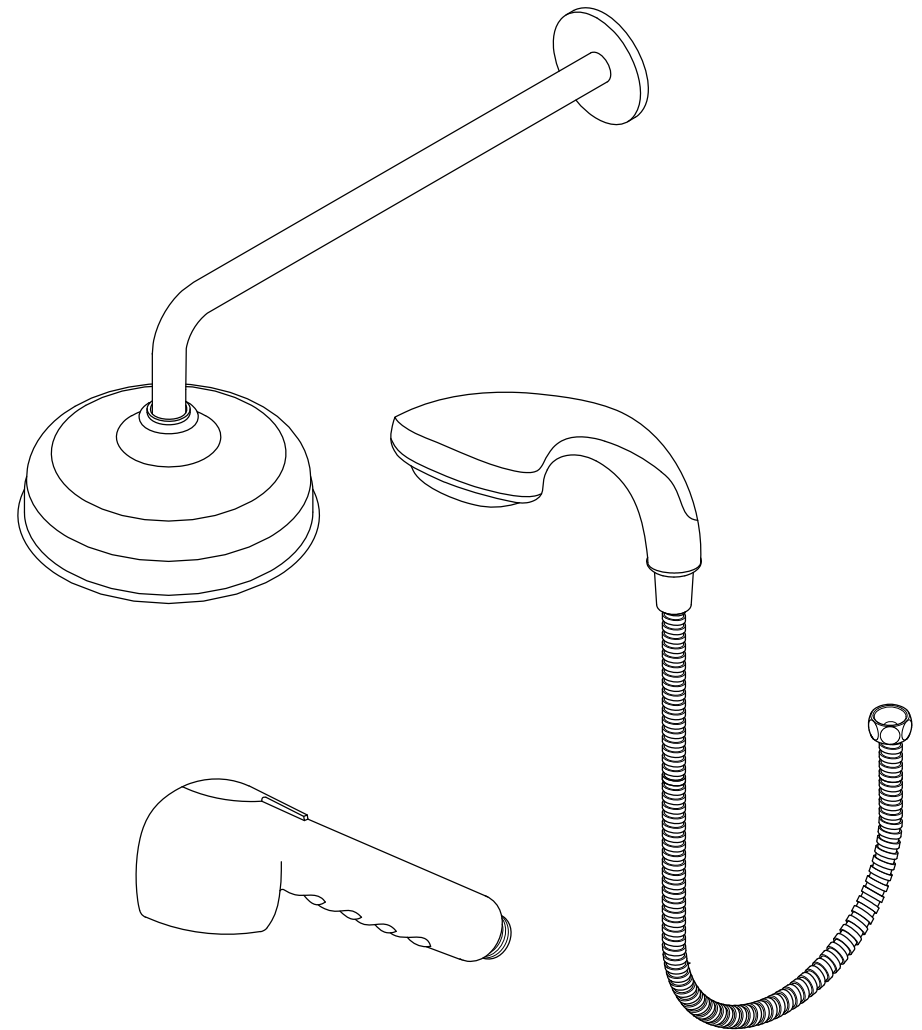

## NOTICE

Failure to follow all directions may cause leaks  
which may result in water damage

[www.kingstonbrass.com](http://www.kingstonbrass.com)  
TOLL-FREE CUSTOMER SERVICE: 1-877-2-KBRASS  
TECHNICAL SUPPORT E-mail: [service@kingstonbrass.com](mailto:service@kingstonbrass.com)  
12775 Reservoir Street, Chino, CA 91710

# KINGSTON

KITCHEN & BATH

## INSTALLATION INSTRUCTIONS Showerhead Sets, Hand Shower Sets and Pull-Out & Pull-Down Sprayer

### Before installation:

Hold the existing shower arm up and down to ensure the plumbing behind the wall is rigid to hold the weight of the new shower unit - about 3-4 lbs when filled with water.

### Installation manual for shower arm & showerhead:

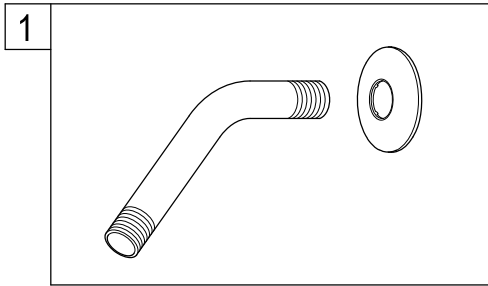

1. Place the flange into the shower rod.

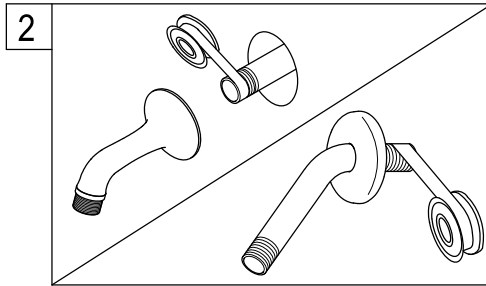

2. Wrap threads on one end of shower rod or the plumbing male nipple with 3 wraps of Teflon tape.

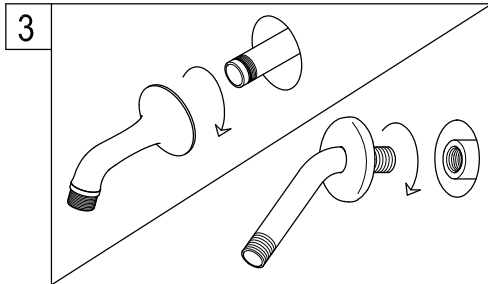

3. Thread the male nipple into female nipple (in wall), tighten with pipe wrench.

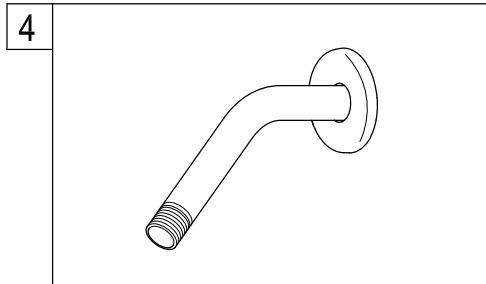

4. Turn the water on and check for leaks, any leaks will require minor tightening or adjustment.

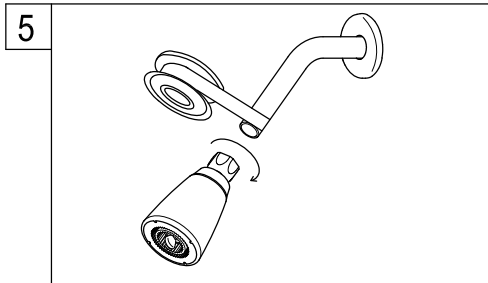

5. Wrap Teflon tape around all the threads on shower rod and hand tighten the showerhead clockwise.

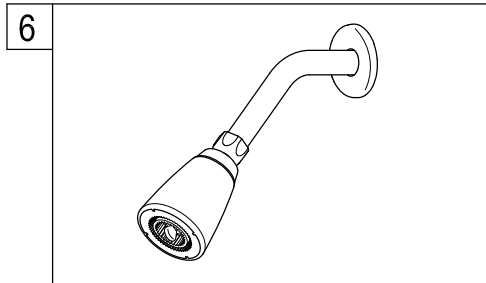

6. Turn the water on and check for leaks, any leaks will require minor tightening or adjustment. If the showerhead leaks at the connection to the thread shower arm, tighten the connection some more by using a wrench.

### Need Tools:

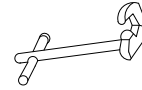

Basin Wrench

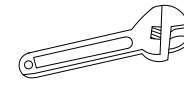

Adjustable Wrench



Pipe Wrench

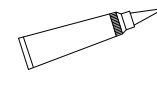

Silicone Sealant



Teflon Tape

### Installation manual for hand shower :

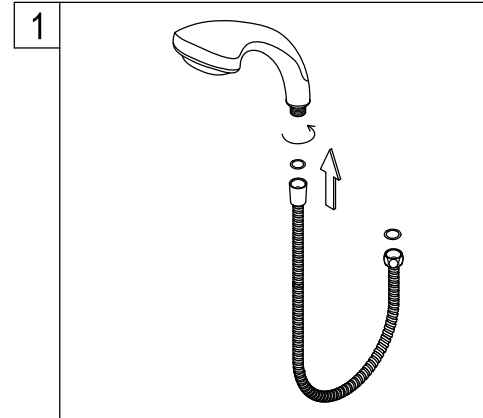

1. Put a washer to the cone shape hose nut and hand tightens the hand shower clockwise.

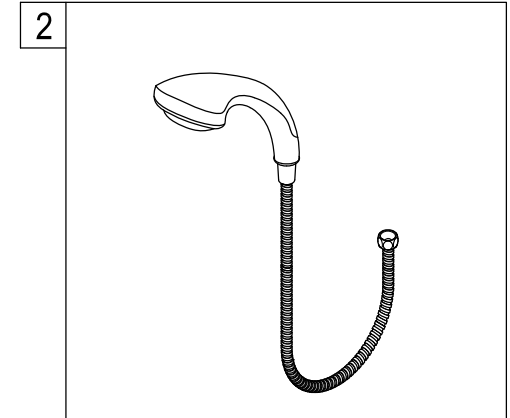

2. Turn on the water and check for leaks, if the hand shower leaks at the connection to the hose, hand tighten the connection some more.

### Installation manual for pull-out & pull-down sprayer:

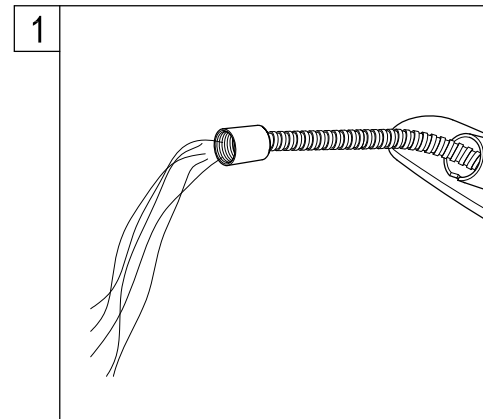

1. Thread hose to spray head and feed from the top into the faucet spout, turn the spout to the right or to the left fully to facilitate the insertion of the hose.

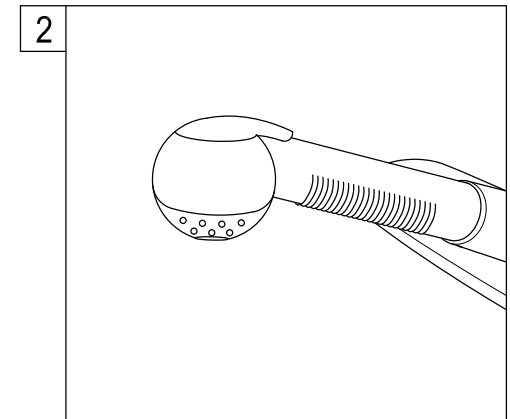

2. After applying Teflon tape thread other end of hose to spray hose outlet, located underneath the faucet. Remove sprayhead and let water run for at least one minute to eject any debris remaining on the line, reinstall sprayhead.

# KINGSTON

KITCHEN & BATH

## Double Offset Bath Supply Installation

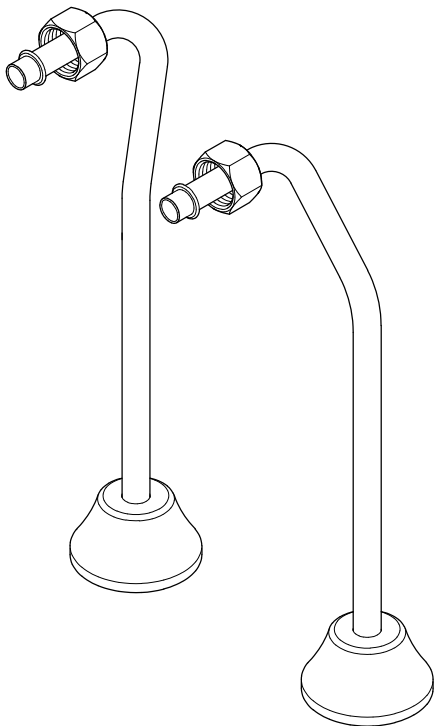

### Parts:

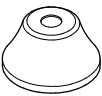
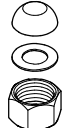
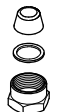
Escutcheon	Cone Washer & Coupling Nut & Friction Ring (3/4-14 NPS)	Cone Washer & Coupling Nut & Friction Ring (1/2-14 NPS)
		
2 Pcs	2 Pcs	4 Pcs

## NOTICE

Failure to follow all directions may cause leaks which may result in water damage

www.kingstonbrass.com  
 TOLL-FREE CUSTOMER SERVICE: 1-877-2-KBRASS  
 TECHNICAL SUPPORT E-mail: service@kingstonbrass.com  
 12775 Reservoir Street, Chino, CA 91710

### Before starting the installation :

Straight supply lines are designed to be installed on tubs that are configured for deck mount faucets, and should be installed at the same center to center distance as that of the tub faucet holes, the supply lines should be installed in a plumb vertical position ,before starting the installation we recommend:

- That you have the supply lines and faucet at the jobsite prior to preparing the rough-in water supply.
- Decide if you are going to add shut-off stops to your supply lines, and if so, have them on-site.

### Installation Steps:

If you are using shut-off stops:

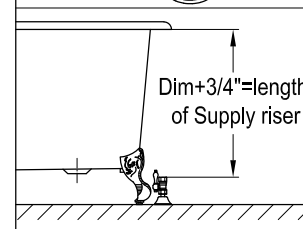
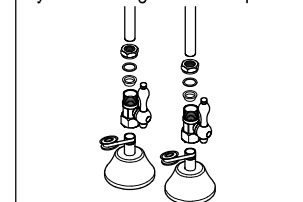

If you are not using shut-off stops:

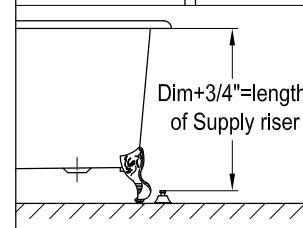
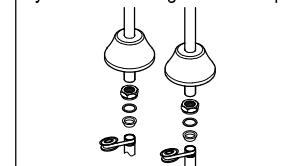

1. Place the tub at the desired location and install the faucet on the tub, using the supply lines mark the location where the supply pipe rough-in should be located, taking into account that the supply line will be recessed into the faucet shank up to the built-in ridge stop, the supply lines are designed to be installed in a vertical plumb position, make sure the rough-in water supply pipes are well secured to impede any movement that would pull on the connection to the supply lines.
2. Rough in the supply pipe to accommodate either the shut-off stops or the supply line.
3. If you are using shut-off stops, make sure that the outlets on the shut-off stops are designed for a 1/2" compression outlet, you will also need to add a flange that will accommodate the diameter of the pipe that you are using as a supply rough-in, install flange and shut-off stop, measure the distance between the top of the shut-off valve and the center of the faucet holes on the tub and add 3/4", cut supply line to the appropriate dimension.
4. If you are not using shut-off stops, measure from the center of the faucet inlet shanks to the fitting on your supply line rough-in and add 3/4", this will determine the height of your supply line allowing enough space so that the supply line is inserted sufficiently into your fitting and does not pull on the supply line as this may cause leaking, cut supply line at the appropriate dimension.
5. Slide the friction washer and cone washer on the horizontal section of the supply line, from the bottom slide the nut all the way to the top, slide in bell flange, 1/2" nut, friction washer and cone washer, apply Teflon tape and thread into your rough-in pipe or shut-off valve.
6. Apply Teflon tape on the faucet shanks and thread the coupling nuts, open the shut-off valves and check for leaks.

### Warning!!!

- Make sure that supply lines are installed in a vertical plumb position, failure to do so may pull on the supply lines and cause leaking.
- Reshaping, bending or altering supply line (except for cutting to size) or use of nuts or washers not supplied with this kit will void your warranty.
- It is recommended that the tub be situated in an area where the supply lines are not exposed to foot traffic, bumping into the supply lines may damage them and potentially cause a leak.

### Installer:

Please pass this label on to homeowner after installation.

# KINGSTON

KITCHEN & BATH

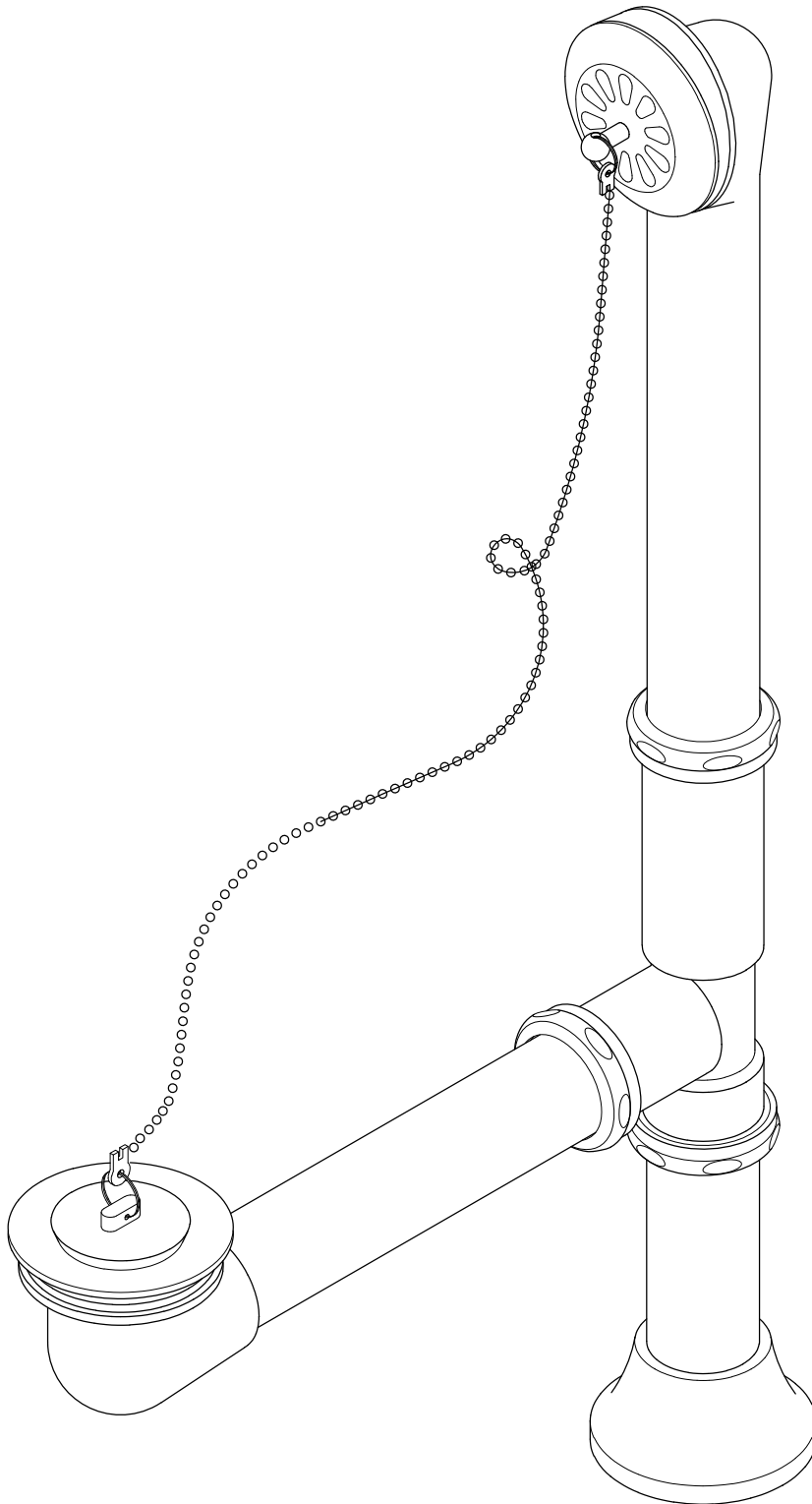

## NOTICE

Failure to follow all directions may cause leaks  
which may result in water damage

[www.kingstonbrass.com](http://www.kingstonbrass.com)

TOLL-FREE CUSTOMER SERVICE: 1-877-2-KBRASS

TECHNICAL SUPPORT E-mail: [service@kingstonbrass.com](mailto:service@kingstonbrass.com)

12775 Reservoir Street, Chino, CA 91710

# KINGSTON

KITCHEN & BATH

## INSTALLATION INSTRUCTIONS

### Brass Tub Bath Drain

- Note:
1. Observe all local plumbing and building codes.
  2. Inspect waste and supply tubing; replace if necessary.
  3. If you are installing a new bath, install the drain before installing the bath.  
Refer to the manufacturer's installation instructions.
  4. The brass tube on (4) or (9) is glued on its elbow and can be trimmed to fit the tub.  
Don't try to disassemble the brass tube from elbow, or it will cause water leakage.

#### TOOLS REQUIRED

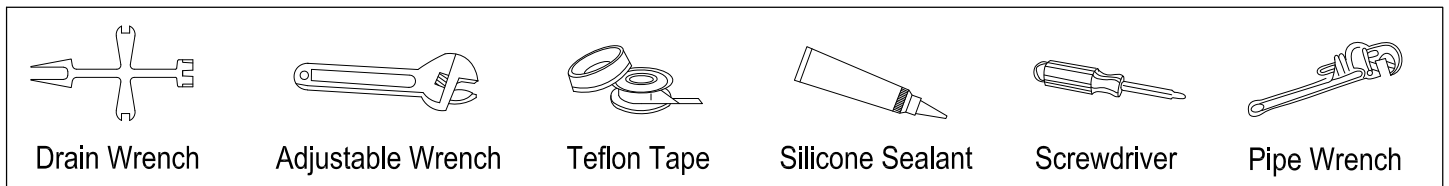

#### INSTALLATION INSTRUCTIONS:

1. Place rubber washer (10) onto waste tube (9) and set them under the tub.
2. Apply Teflon tape on strainer thread and a bead of silicone sealant under waste strainer (11) and thread into waste tube (9). Wipe off excess sealant.
3. Because the back slope angle on tubs vary, we have included 2 gaskets for you, select the rubber gasket that more closely matches your tubs angle, discard remaining rubber gasket. Place rubber gasket (3 or 3-1) on elbow portion of the overflow tube, hold to the back of the tub at the overflow opening and screw in cover plate.
4. Slip joint nuts (5) and Washers (6) onto overflow tube (4), waste tube (9) and drain tube (8).
5. Apply Teflon tape to all three threads on three way tee (7).
6. Slip tee onto the waste tube (9), overflow tube (4) and drain tube (8), adjust to desired location and tighten slip joint nuts.  
Depending on the size of your tub it may be necessary to cut any or both tubes.
7. Thread on drain tube (8) and onto the escutcheon (12), make the necessary connection to your drain system.
8. Fill tub with water, sufficient to cover the overflow cover plate (2), check for leaks and retighten any connections as necessary.

