

## Parts:

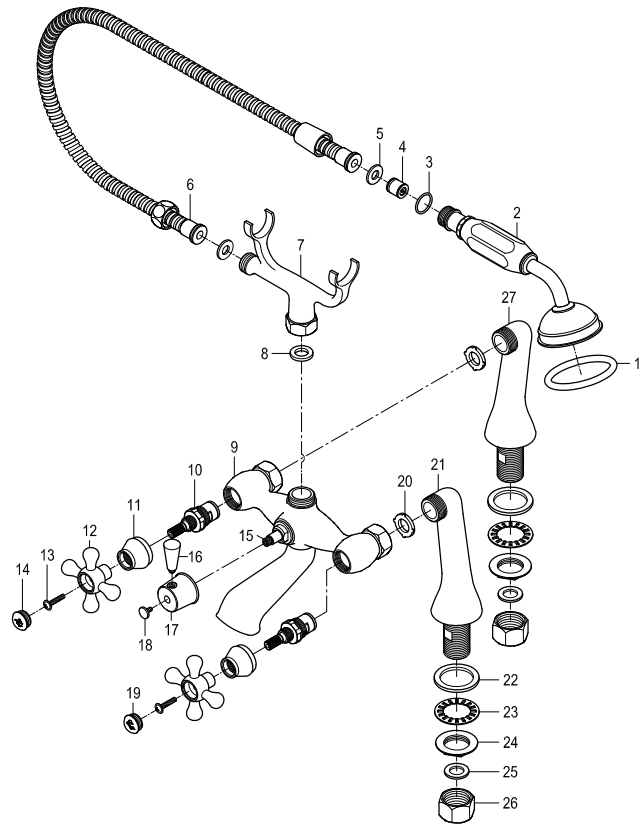

## Replacement Parts:



Cartridge: KS1000H

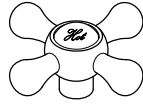

Hot Handle: KSH266H

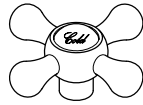

Cold Handle: KSH266C

# KINGSTON

KITCHEN & BATH

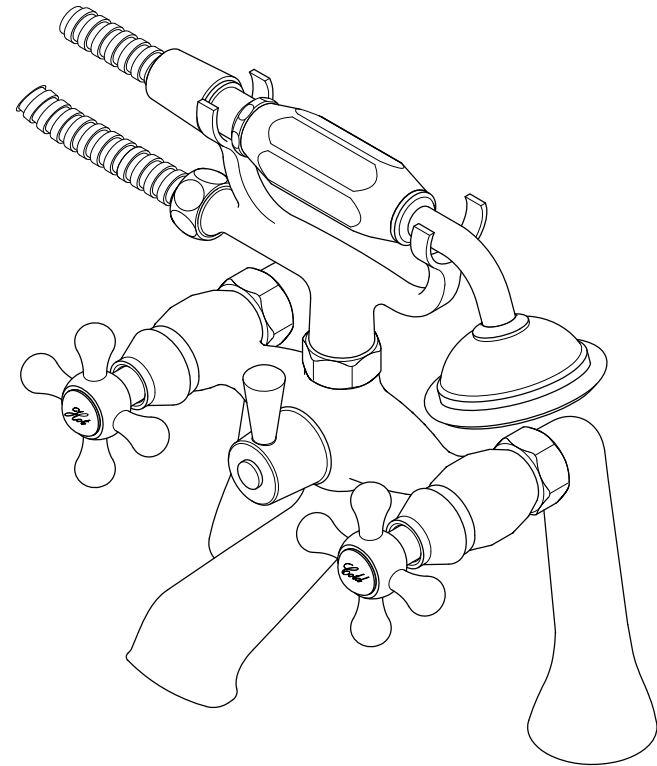

## CARE AND MAINTENANCE OF YOUR FAUCET

Your Kingston Brass faucet has been finished to the most strict standards; however, due to the high content of minerals in the water, your finish may appear dull and tarnished after time. These are some do's and don'ts to maintain the luster on your faucet for many years to come.

### DO

1. Use a silicon based caulking when installing.
2. Clean your faucet with only a mild soap and water solution.
3. Dry your faucet after using it.
4. Give it a coat of Carnuba Wax periodically.

### DON'T

1. Use plumbers putty when installing the faucet.
2. Use any abrasive cleaning agents.

It may seem like a very simple and short list but it is that simple to maintain your faucet, looking shiny and new.

If your faucet is already looking somewhat dull and tarnished, before replacing it, try cleaning it with a 50/50 solution of vinegar and water, you may need to soak some rags and wrap around those stubborn areas, leave overnight and rinse completely in the morning, apply Carnuba wax once you have removed the mineral deposits.

## NOTICE

Failure to follow all directions may cause leaks  
which may result in water damage

[www.kingstonbrass.com](http://www.kingstonbrass.com)

TOLL-FREE CUSTOMER SERVICE: 1-877-2-KBRASS  
TECHNICAL SUPPORT E-mail: [service@kingstonbrass.com](mailto:service@kingstonbrass.com)  
12775 Reservoir Street, Chino, CA 91710

# KINGSTON

KITCHEN & BATH

## INSTALLATION INSTRUCTIONS Deck Mount Tub Filler with Hand Shower

※ This faucet is to be installed on a horizontal surface or tub deck with 7" center to center faucet holes.

### BEFORE BEGINNING INSTALLATION:

1. Flush both supply lines to clear any debris
2. Shut off both supply lines after flushing.

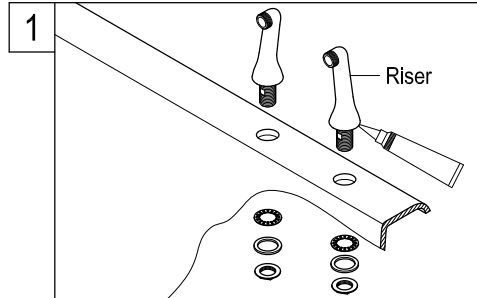

1. Apply a bead of silicone caulking to the underside of the faucet risers and insert from above, hand tighten the lock nuts from underneath, do not over tighten as you may need to adjust the risers position.

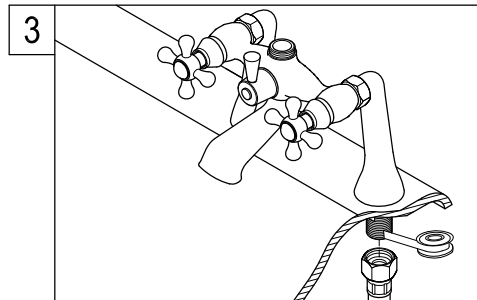

3. Apply Teflon tape to the faucet risers shanks and attach supply lines.

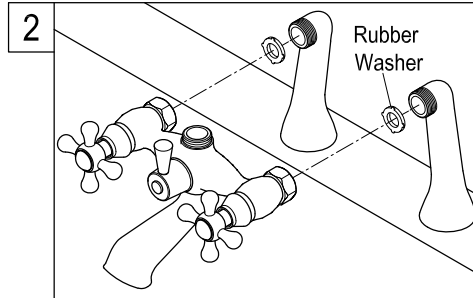

2. Insert the black rubber washers onto the faucet inlets and thread faucet to the faucet risers, tighten lock nuts on faucet risers to fix the faucets position, clean any excess caulking.

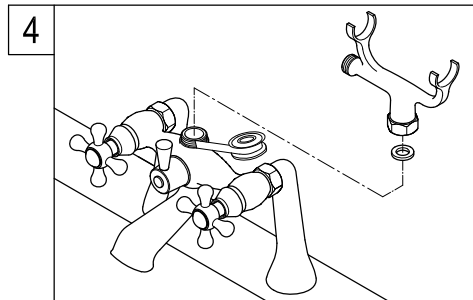

4. Apply Teflon tape to top faucet outlet and thread on handshower cradle, hose outlet may face either direction.

### Need Tools:

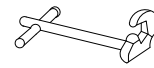

Basin Wrench



Adjustable Wrench



Teflon Tape

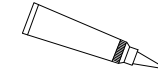

Silicone Sealant

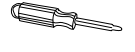

Screwdriver

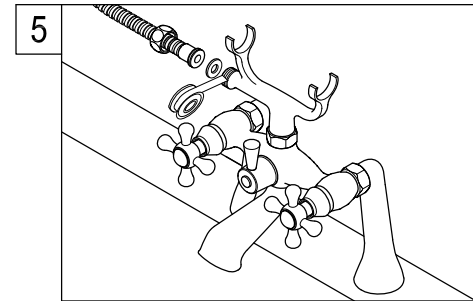

5. Apply Teflon tape to hose outlet on cradle and thread on hose, making sure the rubber washer has been inserted.

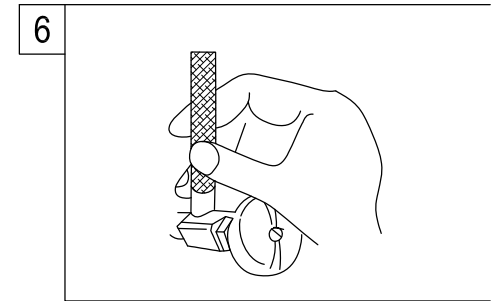

6. Keeping faucet valves closed open both hot and cold water supplies, and check for leaks at faucet risers to the supply lines and faucet.

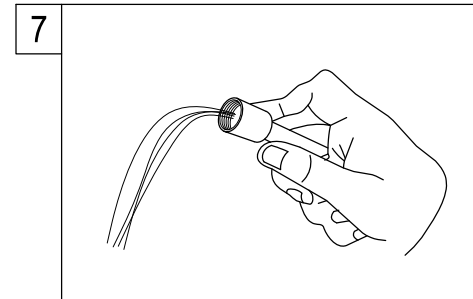

7. If no leaks are visible, open both hot and cold valves on faucet and let water run for 1 minute; turn diverter clockwise to allow water to flow out of hose, let water run for 1 minute.

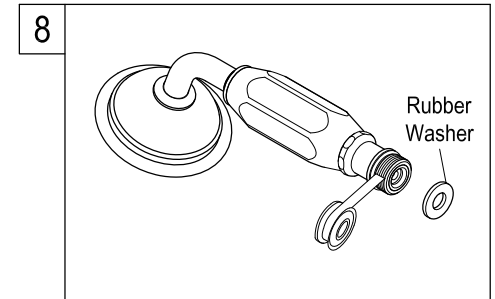

8. Apply Teflon tape on handshower inlet threads and thread on to hose, making sure the rubber washer has been inserted.

### Warning!!!

- Do not put any weight, step, or hang on any part of this faucet, this may damage the faucet and cause water damage.
- This faucet was tested and meets ASME/ANSI standards of operation and torque tension; do not use pneumatic or electrical tools for its installation, as this may inadvertently over tighten the connection or attachment hardware of this faucet.
- It is recommended that the tub be situated in an area where the supply lines are not exposed to foot traffic, bumping into the supply lines may damage them and potentially cause a leak.

# KINGSTON

KITCHEN & BATH

## Straight Bath Supply Installation

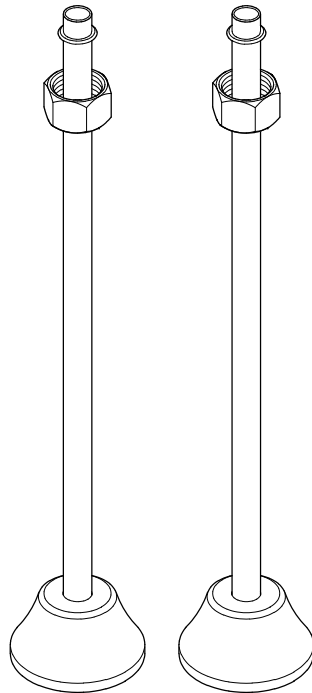

### Parts:

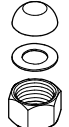
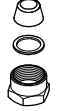
Escutcheon	Cone Washer & Coupling Nut & Friction Ring (3/4-14 NPS)	Cone Washer & Coupling Nut & Friction Ring (1/2-14 NPS)
		
2 Pcs	2 Pcs	4 Pcs

## NOTICE

Failure to follow all directions may cause leaks which may result in water damage

www.kingstonbrass.com  
 TOLL-FREE CUSTOMER SERVICE: 1-877-2-KBRASS  
 TECHNICAL SUPPORT E-mail: service@kingstonbrass.com  
 12775 Reservoir Street, Chino, CA 91710

### Before starting the installation :

Straight supply lines are designed to be installed on tubs that are configured for deck mount faucets, and should be installed at the same center to center distance as that of the tub faucet holes, the supply lines should be installed in a plumb vertical position ,before starting the installation we recommend:

- That you have the supply lines and faucet at the jobsite prior to preparing the rough-in water supply.
- Decide if you are going to add shut-off stops to your supply lines, and if so, have them on-site.

### Installation Steps:

If you are using shut-off stops:

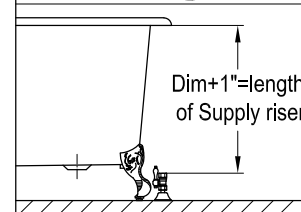
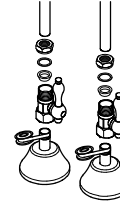

If you are not using shut-off stops:

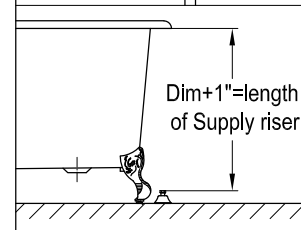
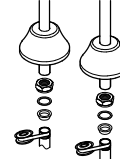

1. Place the tub at the desired location and install the faucet on the tub, using the supply lines mark the location where the supply pipe rough-ins should be located, the supply lines are designed to be installed in a vertical plumb position, make sure the rough-in water supply pipes are well secured to impede any movement that would pull on the connection to the supply lines.
2. Rough in the supply pipe to accommodate either the shut-off stops or the supply line.
3. If you are using shut-off stops, make sure that the outlets on the shut-off stops are designed for a 1/2" compression outlet, you will also need to add a flange that will accommodate the diameter of the pipe that you are using as a supply rough-in, install flange and shut-off stop, measure the distance between the top of the shut-off valve and the bottom of the faucet shanks and add 1", cut supply line on the appropriate dimension.
4. If you are not using shut-off stops, measure from the bottom of the faucet shanks to the fitting on your supply line rough-in in and add 1", cut supply line at the appropriate dimension, this will allow enough space so that the supply line is inserted sufficiently into your fitting and does not pull on the supply line as this may cause leaking.
5. Slide the friction washer and cone washer and nut onto the supply line, slide in bell flange, 1/2" nut, friction washer and cone washer, apply Teflon tape and thread into your rough-in pipe or shut-off valve.
6. Apply Teflon tape on the faucet shanks and thread the coupling nuts, open the shut-off valves and check for leaks.

### Warning!!!

- Make sure that supply lines are installed in a vertical plumb position, failure to do so may pull on the supply lines and cause leaking.
- Reshaping, bending or altering supply line (except for cutting to size) or use of nuts or washers not supplied with this kit will void your warranty.
- It is recommended that the tub be situated in an area where the supply lines are not exposed to foot traffic, bumping into the supply lines may damage them and potentially cause a leak.

### Installer:

Please pass this label on to homeowner after installation.

# KINGSTON

KITCHEN & BATH

## INSTALLATION INSTRUCTIONS

### Straight Stop

#### Instructions:

1. Apply thread sealant tape to threads (1).
2. Screw valve body (2) onto pipe (3).
3. Place nut (4), metal washer (5) and rubber washer (6) on tube (7).
4. Insert tube (7) into valve.
5. Wrench tighten nut (4) onto valve.
6. Stop any leaks by tightening nuts slightly.

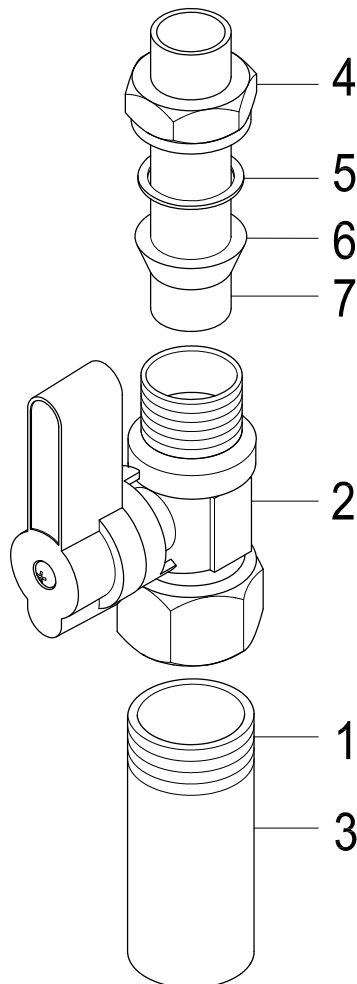

### NOTICE

Failure to follow all directions may cause leaks  
which may result in water damage

[www.kingstonbrass.com](http://www.kingstonbrass.com)  
TOLL-FREE CUSTOMER SERVICE: 1-877-2-KBRASS  
TECHNICAL SUPPORT E-mail: [service@kingstonbrass.com](mailto:service@kingstonbrass.com)  
12775 Reservoir Street, Chino, CA 91710

# KINGSTON

KITCHEN & BATH

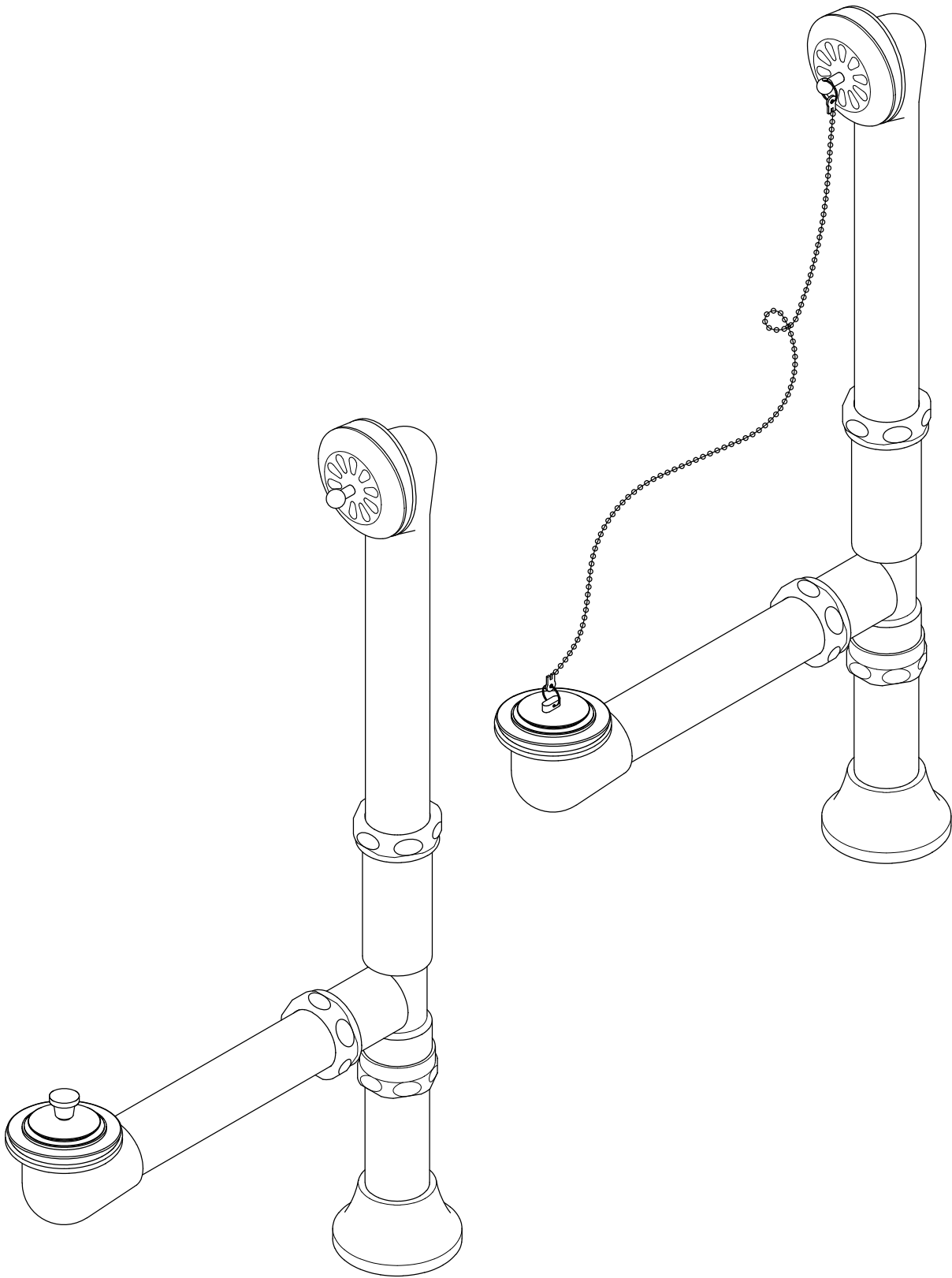

## NOTICE

Failure to follow all directions may cause leaks  
which may result in water damage

[www.kingstonbrass.com](http://www.kingstonbrass.com)

TOLL-FREE CUSTOMER SERVICE: 1-877-2-KBRASS

TECHNICAL SUPPORT E-mail: [service@kingstonbrass.com](mailto:service@kingstonbrass.com)

12775 Reservoir Street, Chino, CA 91710

# KINGSTON

KITCHEN & BATH

## INSTALLATION INSTRUCTIONS

### Brass Tub Bath Drain

- Note:
1. Observe all local plumbing and building codes.
  2. Inspect waste and supply tubing; replace if necessary.
  3. If you are installing a new bath, install the drain before installing the bath.  
Refer to the manufacturer's installation instructions.
  4. The brass tube on (4) or (9) is glued on its elbow and can be trimmed to fit the tub.  
Don't try to disassemble the brass tube from elbow, or it will cause water leakage.

#### TOOLS REQUIRED

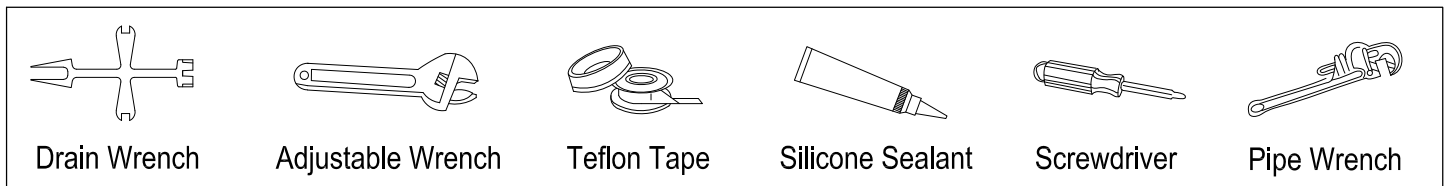

#### INSTALLATION INSTRUCTIONS:

1. Place rubber washer (10) onto waste tube (9) and set them under the tub.
2. Apply Teflon tape on strainer thread and a bead of silicone sealant under waste strainer (11) and thread into waste tube (9). Wipe off excess sealant.
3. Because the back slope angle on tubs vary, we have included 2 gaskets for you, select the rubber gasket that more closely matches your tubs angle, discard remaining rubber gasket. Place rubber gasket (3 or 3-1) on elbow portion of the overflow tube, hold to the back of the tub at the overflow opening and screw in cover plate.
4. Slip joint nuts (5) and Washers (6) onto overflow tube (4), waste tube (9) and drain tube (8).
5. Apply Teflon tape to all three threads on three way tee (7).
6. Slip tee onto the waste tube (9), overflow tube (4) and drain tube (8), adjust to desired location and tighten slip joint nuts.  
Depending on the size of your tub it may be necessary to cut any or both tubes.
7. Thread on drain tube (8) and onto the escutcheon (12), make the necessary connection to your drain system.
8. Fill tub with water, sufficient to cover the overflow cover plate (2), check for leaks and retighten any connections as necessary.

