

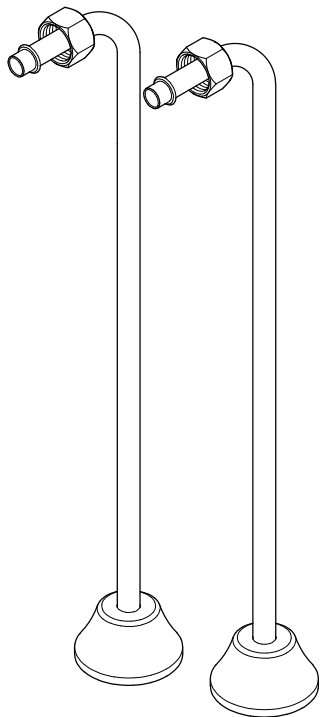

KINGSTON

KITCHEN & BATH

Single Offset Bath Supply Installation

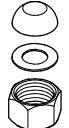
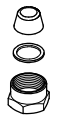

Parts:

Escutcheon	Cone Washer & Coupling Nut & Friction Ring (3/4-14 NPS)	Cone Washer & Coupling Nut & Friction Ring (1/2-14 NPS)
		
2 Pcs	2 Pcs	4 Pcs

NOTICE

Failure to follow all directions may cause leaks which may result in water damage

www.kingstonbrass.com
 TOLL-FREE CUSTOMER SERVICE: 1-877-2-KBRASS
 TECHNICAL SUPPORT E-mail: service@kingstonbrass.com
 12775 Reservoir Street, Chino, CA 91710

Before starting the installation :

Straight supply lines are designed to be installed on tubs that are configured for deck mount faucets, and should be installed at the same center to center distance as that of the tub faucet holes, the supply lines should be installed in a plumb vertical position ,before starting the installation we recommend:

- That you have the supply lines and faucet at the jobsite prior to preparing the rough-in water supply.
- Decide if you are going to add shut-off stops to your supply lines, and if so, have them on-site.

Installation Steps:

If you are using shut-off stops:

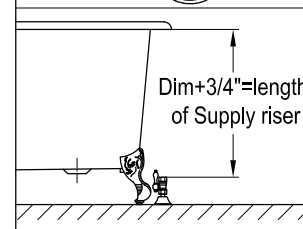
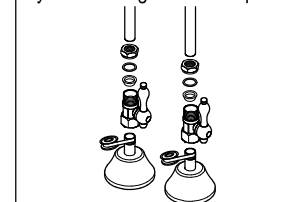

If you are not using shut-off stops:

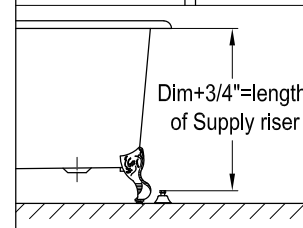
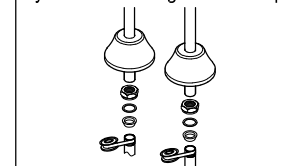

1. Place the tub at the desired location and install the faucet on the tub, using the supply lines mark the location where the supply pipe rough-in should be located, taking into account that the supply line will be recessed into the faucet shank up to the built-in ridge stop, make sure that the center to center dimension on the rough-in pipe is the same as the center to center distance of the faucet holes on the tub, the supply lines are designed to be installed in a vertical plumb position, make sure the rough-in water supply pipes are well secured to impede any movement that would pull on the connection to the supply lines.
2. Rough in the supply pipe to accommodate either the shut-off stops or the supply line.
3. If you are using shut-off stops, make sure that the outlets on the shut-off stops are designed for a 1/2" compression outlet, you will also need to add a flange that will accommodate the diameter of the pipe that you are using as a supply rough-in, install flange and shut-off stop, measure the distance between the top of the shut-off valve and the center of the faucet holes on the tub and add 3/4", cut supply line to the appropriate dimension.
4. If you are not using shut-off stops, measure from the center of the faucet inlet shanks to the fitting on your supply line rough-in and add 3/4", this will determine the height of your supply line allowing enough space so that the supply line is inserted sufficiently into your fitting and does not pull on the supply line as this may cause leaking, cut supply line at the appropriate dimension.
5. Slide the friction washer and cone washer on the horizontal section of the supply line, from the bottom slide the nut all to the top, slide in bell flange, 1/2" nut, friction washer and cone washer, apply Teflon tape and thread into your rough-in pipe or shut-off valve.
6. Apply Teflon tape on the faucet shanks and thread the coupling nuts, open the shut-off valves and check for leaks.

Warning!!!

- Make sure that supply lines are installed in a vertical plumb position, failure to do so may pull on the supply lines and cause leaking.
- Reshaping, bending or altering supply line (except for cutting to size) or use of nuts or washers not supplied with this kit will void your warranty.
- It is recommended that the tub be situated in an area where the supply lines are not exposed to foot traffic, bumping into the supply lines may damage them and potentially cause a leak.

Installer:

Please pass this label on to homeowner after installation.



KINGSTON

KITCHEN & BATH

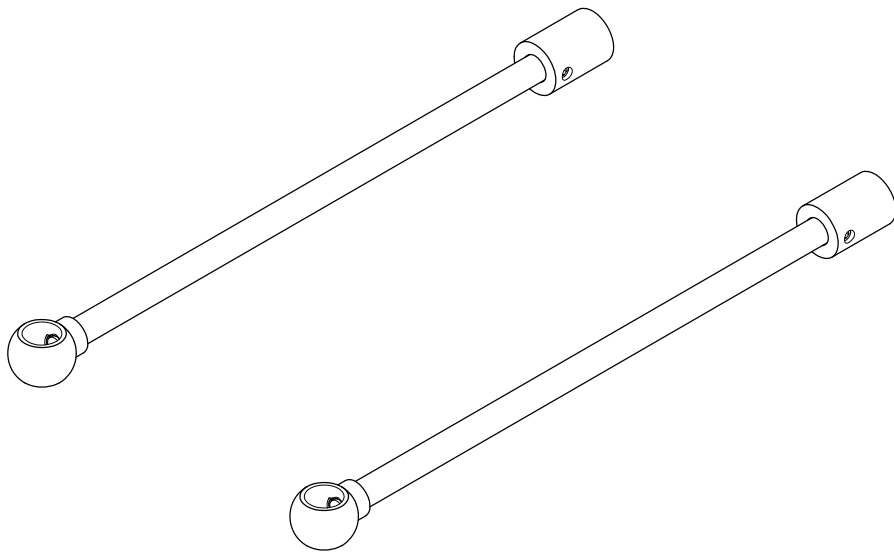
Wall Support Brackets Installation

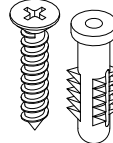

Parts:

Slotted Set Screw	Set Screw	Mounting Screw & Anchor
		
2 Pcs	2 Pcs	2 Pcs

www.kingstonbrass.com
 TOLL-FREE CUSTOMER SERVICE: 1-877-2-KBRASS
 TECHNICAL SUPPORT E-mail: service@kingstonbrass.com
 12775 Reservoir Street, Chino, CA 91710

TOOLS REQUIRED

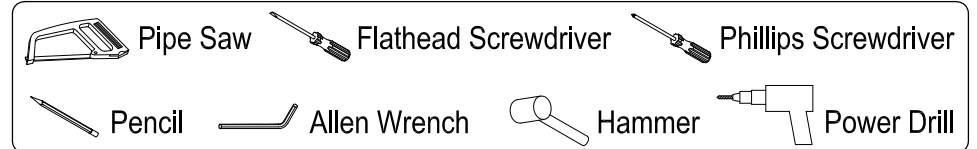

Before Installation

After Installation

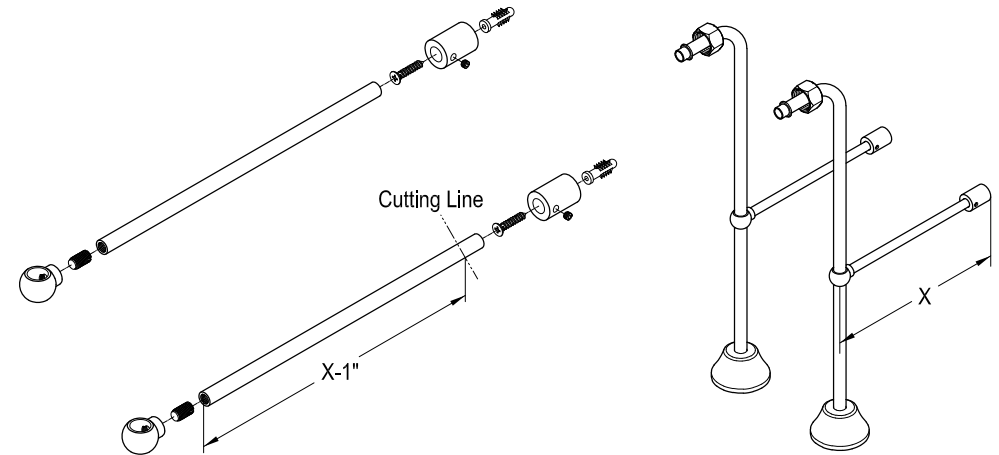

Installation Steps:

- Step 1. Unthread ring from the support rod by turning counter-clockwise.
- Step 2. Slide ring onto the supply line and secure at the desired position by tightening the screw using a flathead screwdriver, do not over-tighten as this may damage the supply line.
- Step 3. Locate the proper position where the wall bracket will be installed, drill hole for anchor on the wall and secure the wall bracket with the enclosed screw.
- Step 4. The maximum distance allowed with this wall support rod is 10-1/2" if you need a shorter distance, measure the distance between the center of the supply line and the wall and subtract 1", cut the rod from the end that does not have the inner threads.
- Step 5. Insert the unthreaded end of the support rod onto the wall bracket and thread the rod onto the ring secured at the supply line by turning clockwise, using an Allen hex wrench tighten the set screw.

Warning!!!

Reshaping, bending or altering supply line except for cutting to size Or use of nuts or washers not supplied with this kit will void your warranty.
 Supply lines are designed to be braced to the wall or the overflow tube, Failure to secure properly will void the warranty.
 Please do not pull or lean on the faucet once it has been installed, this may bend or pull the supply line which may cause a leak resulting in possible water damage.