

KINGSTON

KITCHEN & BATH

8



8. Thread machine screw onto the housing, be careful not to over-tighten as this may impede the proper function of the handle. Then Covered the screw hole with a black rubber cap.

9



9. Test levers movement and adjust screw accordingly.

10



10. Insert handshower holder and secure with the washer and screw.

11



11. Do not over-tighten as this may impede the proper adjustment of the handshower.

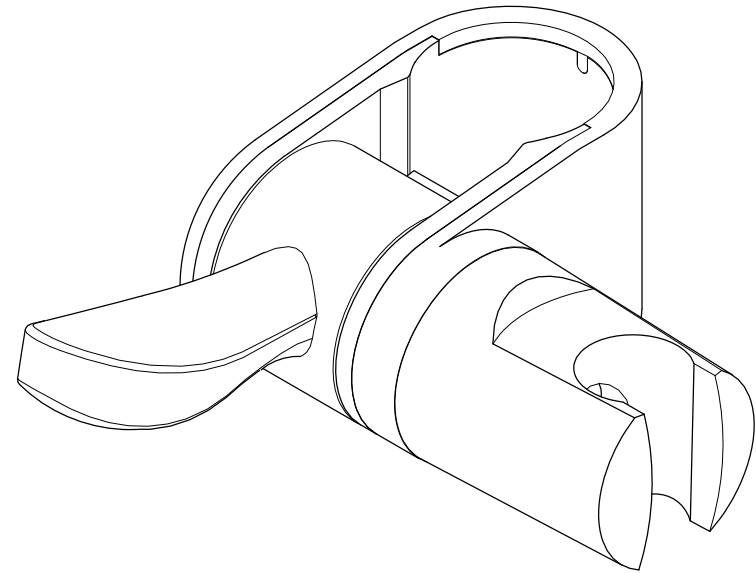

www.kingstonbrass.com
TOLL-FREE CUSTOMER SERVICE: 1-877-2-KBRASS
TECHNICAL SUPPORT E-mail: service@kingstonbrass.com
12775 Reservoir Street, Chino, CA 91710

KINGSTON

KITCHEN & BATH

INSTALLATION INSTRUCTIONS

Add-On Shower Holder for Grab Bar

Need Tools:

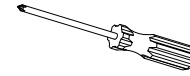

Phillips Screwdriver

1. Using a phillips head screwdriver, remove screw located inside the handshower holder.

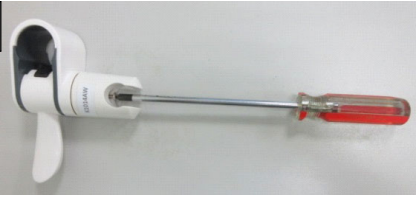

2. Gently pull handshower holder.



3. Remove rubber button and unthread screw.



4. Carefully pull shaft.



5. Remove handle assembly.



6. Insert housing on grab bar and insert handle on housing.



7. Insert shaft, make sure to align flat part on shaft with the flat part on the housing.



KINGSTON

KITCHEN & BATH

Grab Bar Installation

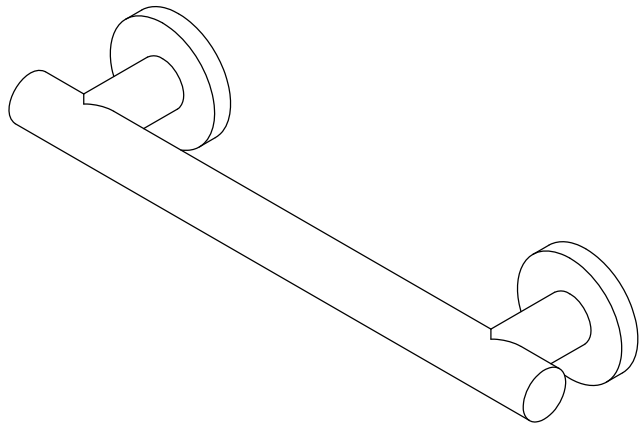

Parts:

Mounting
Screw

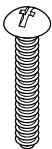

6 Pcs

CAUTION

Failure to follow all installation directions may cause product to detach from the wall and cause serious injury

www.kingstonbrass.com
TOLL-FREE CUSTOMER SERVICE: 1-877-2-KBRASS
TECHNICAL SUPPORT E-mail: service@kingstonbrass.com
12775 Reservoir Street, Chino, CA 91710

TOOLS REQUIRED



Marking Pencil

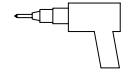

Electric Screwdriver

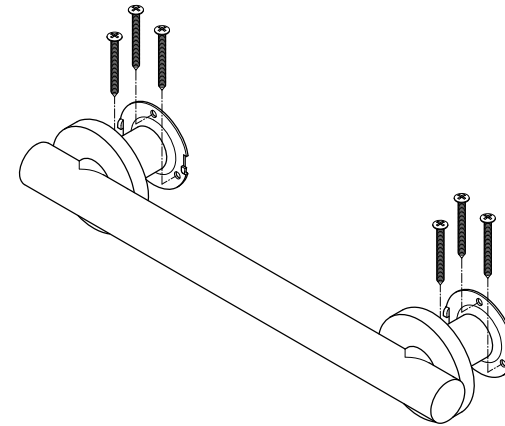

Before you begin your installation:

- For your own safety, this grab bar should be installed by a licensed professional.
- A grab bar is as good as the way it's installed.
- Make sure to confirm that there is proper wood backing at both points of attachment for this grab bar.
- If there is no wood backing no wood backing available at both point, attach a 2" x 6" minimum piece of lumber between the studs.
- Maximum weight capacity is 292 LBS (132 KGS).

Installation Steps:

1. Place bar at the desired location. Level and mark the location of the holes.
2. Remove bar and pre-drive all the screws in at the marked location with electric screwdriver, then remove all the screws from the wall.
3. Place the grab bar back and align the flange base with the screw holes.
4. Due to the tight space, use electric screw driver to drive all the screws only about 1/2 depth, then one by one tighten up all screws to secure the grab bar.
5. Press flanges to the base and turn clockwise to lock in place.

Cleaning

Clean with a damp cloth only.
Avoid using metal or abrasive polishes.

KINGSTON

KITCHEN & BATH

INSTALLATION INSTRUCTIONS

Shower Arm Diverter

Instructions:

1. Remove showerhead, Apply Teflon tape to threads on shower arm as well as the threads on the diverter.
2. After inserting the rubber washer, thread diverter onto showerarm.
3. Thread shower hose onto the bottom outlet on the diverter.
4. Open hot and cold shower valves and let water run for 30 seconds or more from each outlet, this will clear any debris from the line.
5. Thread showerhead to the side outlet.
6. Thread handshower to the end of the hose.

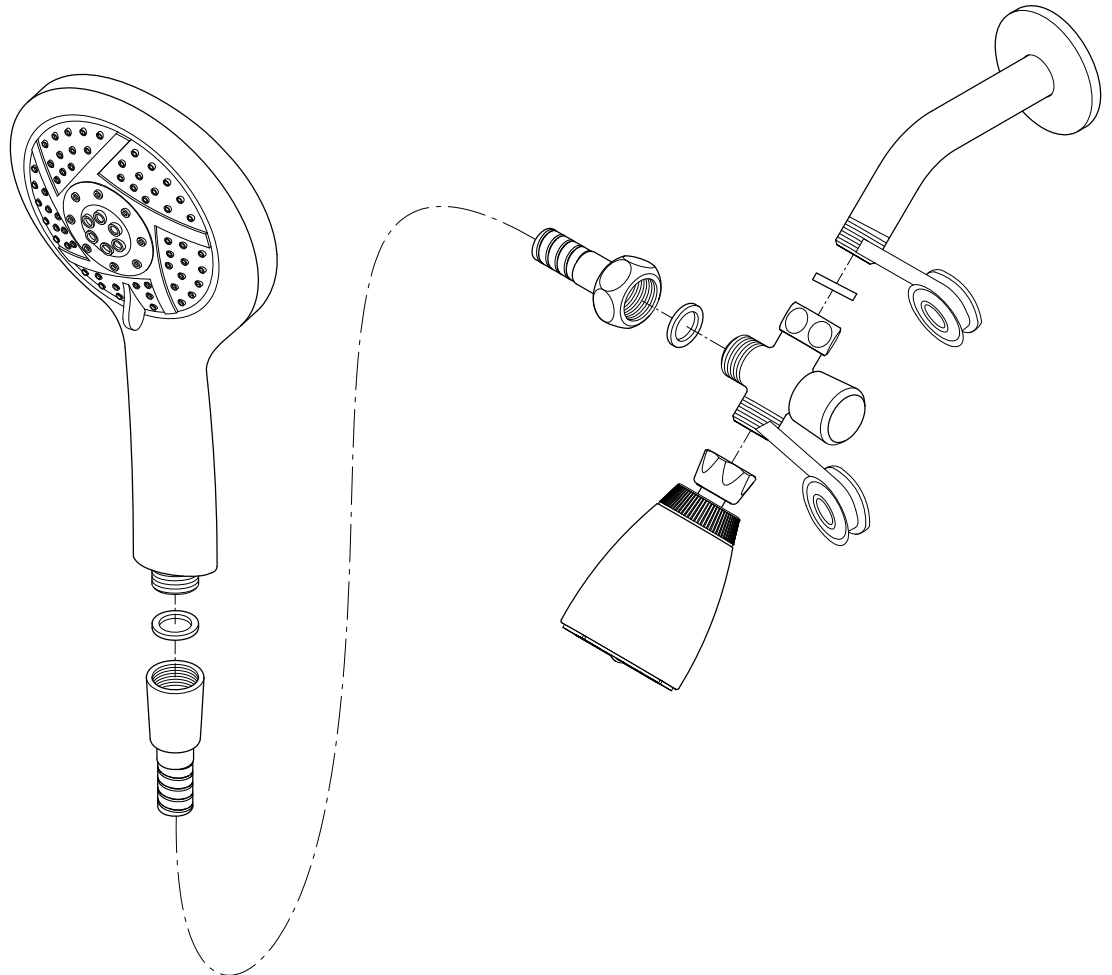

www.kingstonbrass.com

TOLL-FREE CUSTOMER SERVICE: 1-877-2-KBRASS

TECHNICAL SUPPORT E-mail: service@kingstonbrass.com

12775 Reservoir Street, Chino, CA 91710

NOTICE

Failure to follow all directions may cause leaks
which may result in water damage

CAUTION

Failure to follow all installation directions may
cause product to detach from the wall and
cause serious injury

© 2023-11-T Kingston Brass

KINGSTON

KITCHEN & BATH

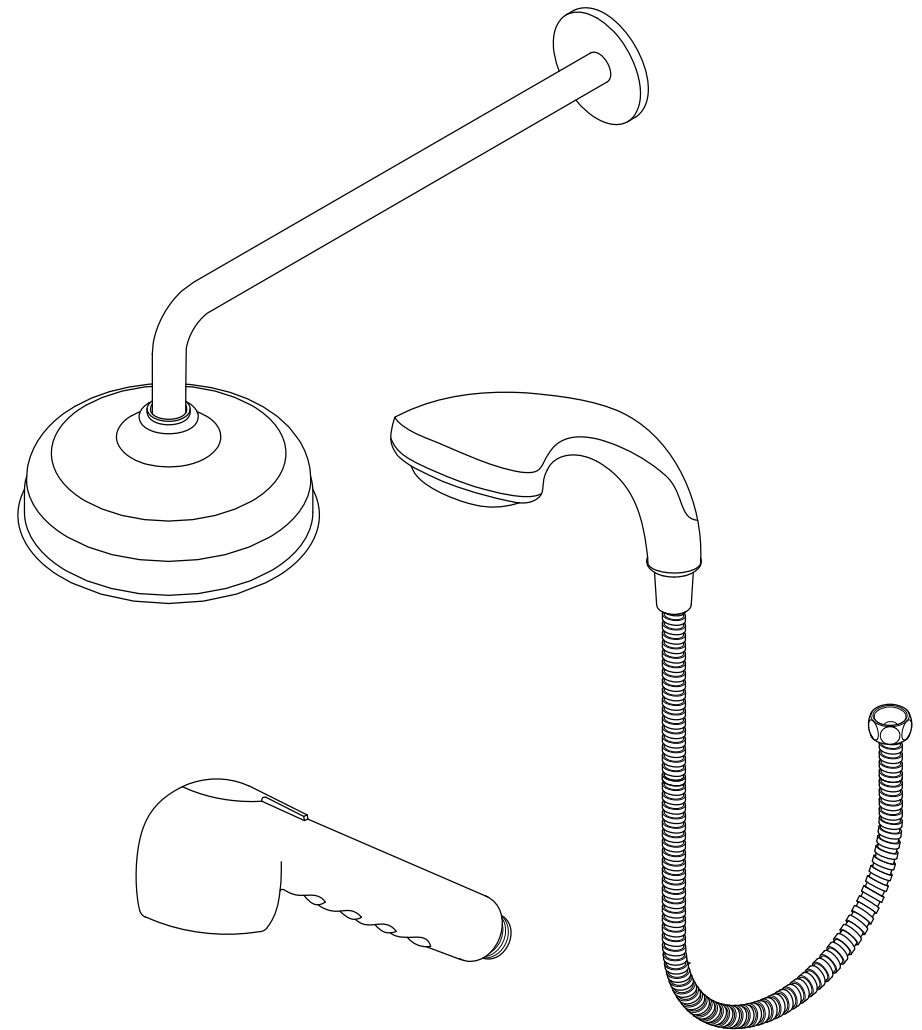

NOTICE

Failure to follow all directions may cause leaks
which may result in water damage

www.kingstonbrass.com
TOLL-FREE CUSTOMER SERVICE: 1-877-2-KBRASS
TECHNICAL SUPPORT E-mail: service@kingstonbrass.com
12775 Reservoir Street, Chino, CA 91710

KINGSTON

KITCHEN & BATH

INSTALLATION INSTRUCTIONS Showerhead Sets, Hand Shower Sets and Pull-Out & Pull-Down Sprayer

Before installation:

Hold the existing shower arm up and down to ensure the plumbing behind the wall is rigid to hold the weight of the new shower unit - about 3-4 lbs when filled with water.

Installation manual for shower arm & showerhead:

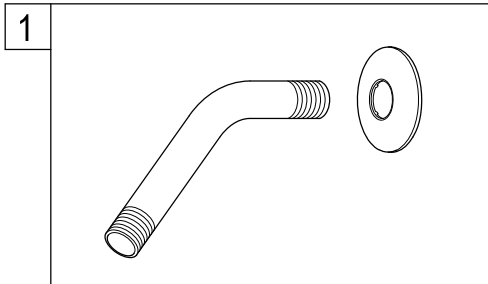

1. Place the flange into the shower rod.

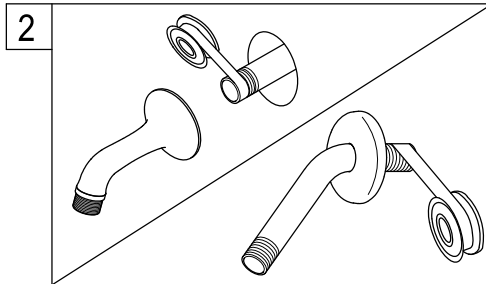

2. Wrap threads on one end of shower rod or the plumbing male nipple with 3 wraps of Teflon tape.

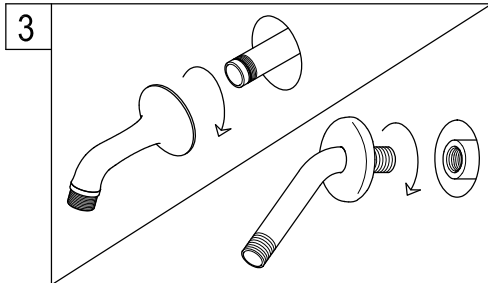

3. Thread the male nipple into female nipple (in wall), tighten with pipe wrench.

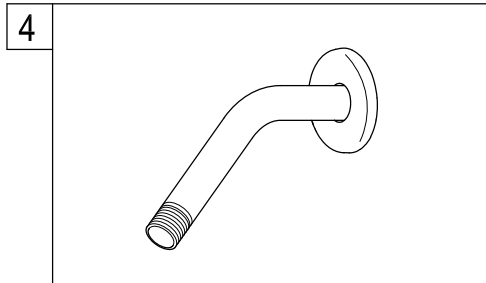

4. Turn the water on and check for leaks, any leaks will require minor tightening or adjustment.

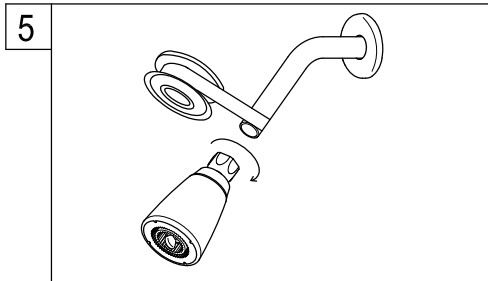

5. Wrap Teflon tape around all the threads on shower rod and hand tighten the showerhead clockwise.

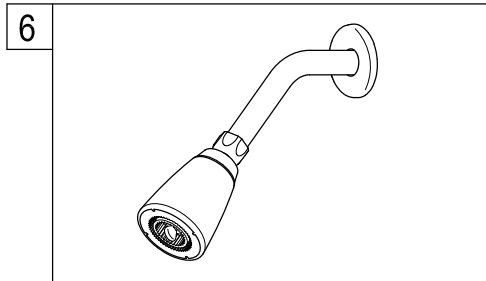

6. Turn the water on and check for leaks, any leaks will require minor tightening or adjustment. If the showerhead leaks at the connection to the thread shower arm, tighten the connection some more by using a wrench.

Need Tools:

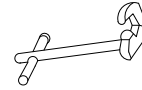

Basin Wrench

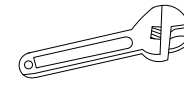

Adjustable Wrench



Pipe Wrench

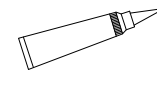

Silicone Sealant



Teflon Tape

Installation manual for hand shower :

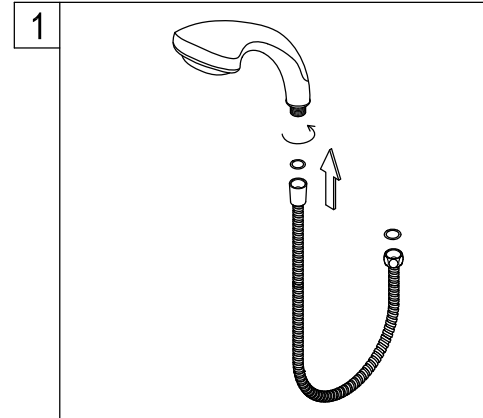

1. Put a washer to the cone shape hose nut and hand tightens the hand shower clockwise.

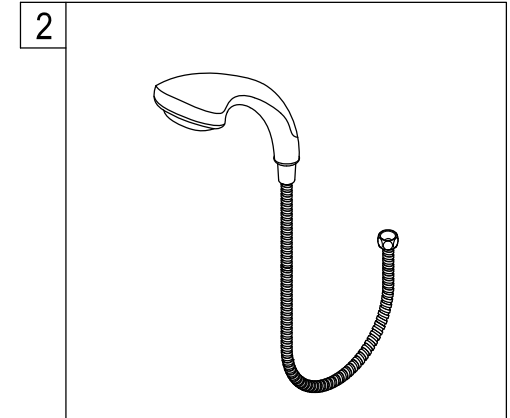

2. Turn on the water and check for leaks, if the hand shower leaks at the connection to the hose, hand tighten the connection some more.

Installation manual for pull-out & pull-down sprayer:

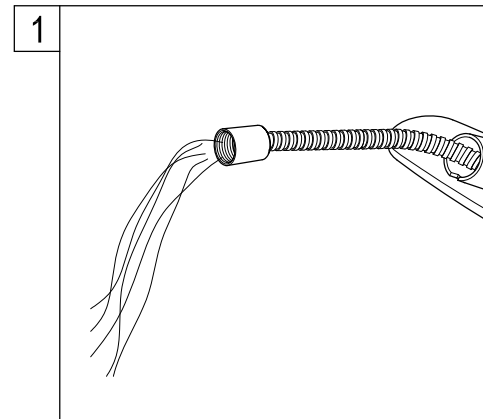

1. Thread hose to spray head and feed from the top into the faucet spout, turn the spout to the right or to the left fully to facilitate the insertion of the hose.

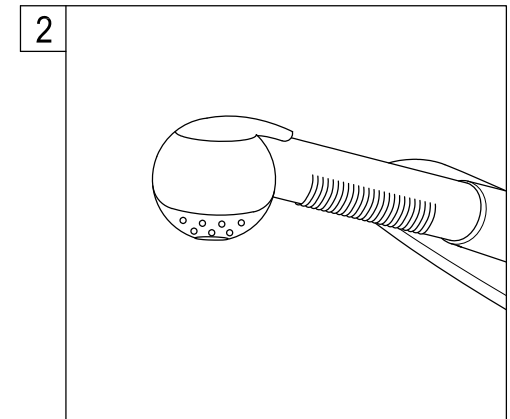

2. After applying Teflon tape thread other end of hose to spray hose outlet, located underneath the faucet. Remove sprayhead and let water run for at least one minute to eject any debris remaining on the line, reinstall sprayhead.