

KINGSTON

KITCHEN & BATH

Shower Seat Wall Mount Hinged Installation

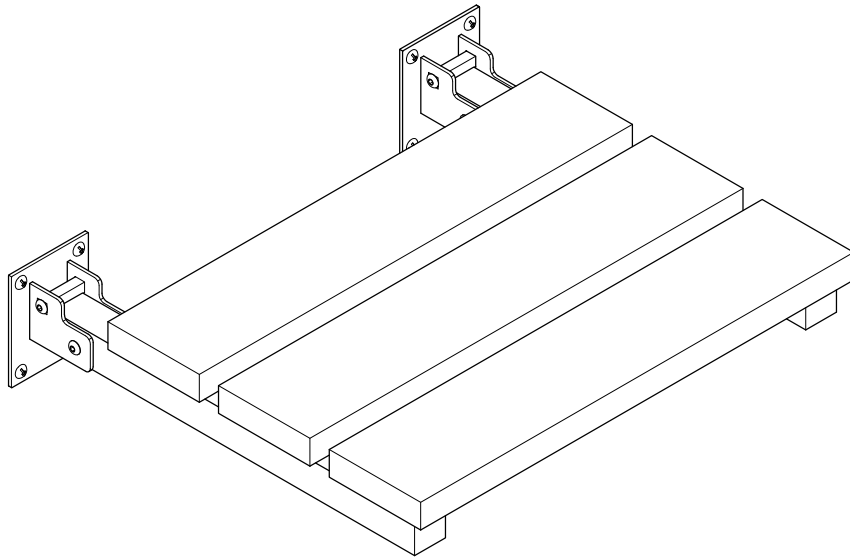

Parts:

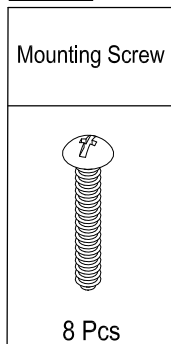

www.kingstonbrass.com
TOLL-FREE CUSTOMER SERVICE: 1-877-2-KBRASS
TECHNICAL SUPPORT E-mail: service@kingstonbrass.com
12775 Reservoir Street, Chino, CA 91710

TOOLS REQUIRED

 Allen Wrench

 Phillips Screwdriver

 Marking Pencil

 Power Drill

Before Installation:

For your own safety, this seat should be installed by a licensed professional. It is recommended that this seat be properly secured to 2" x 6" piece of lumber or larger as wood bracing.

Weight limit on this seat is 120 kgs (265 lbs) max.

Installation Steps:

- Step 1. Locate the desired seating position. To comply with ADA standards, seat should be mounted at a height where the seating surface in its downward position is at a height of 17" to 19" above finished floor. Please check all State and Local code for building requirements.
- Step 2. Place seat at its desired location, make sure the seating surface is level, use a pencil to mark the locations for the screw holes from each mounting plate on the wall. Remove the seat after marking the locations of the mounting holes.
- Step 3. Driving all the screws in at the marked locations with electric screwdriver then remove all the screws from the wall.
- Step 4. Place seat back and align the mounting plates with the pre-drilled screw holes. Drive in all the screws again to secure the seat firmly on the wall with electric screwdriver.
- Step 5. Make sure that the seat raises and lowers smoothly. If correctly installed, the seat will remain in the upward, closed position on its own, and will require minimal effort to be lowered down to the seating position.

Please Read Disclaimer

The manufacturer or distributor of this product shall not be held liable for installation actions taken or not taken. There are many details of installation that are assumed to be general construction knowledge to experienced installers; which are not included in these instructions. Selection of an experienced installer is the sole responsibility of the home owner or architect