

KINGSTON

KITCHEN & BATH

INSTALLATION INSTRUCTIONS

Six-Way Diverter Valve with Trim Kit

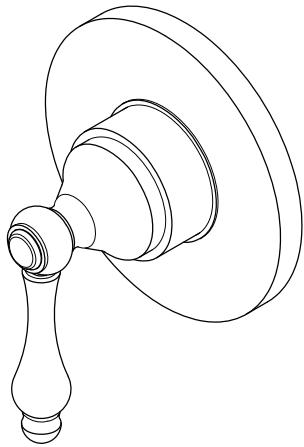
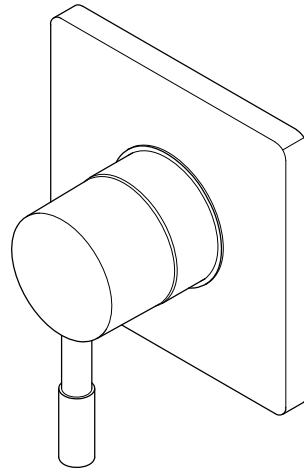

www.kingstonbrass.com
TOLL-FREE CUSTOMER SERVICE: 1-877-2-KBRASS
TECHNICAL SUPPORT E-mail: service@kingstonbrass.com
12775 Reservoir Street, Chino, CA 91710

NOTICE

Failure to follow all directions may cause leaks
which may result in water damage

CAUTION

Failure to follow all installation directions may
cause product to detach from the wall and
cause serious injury

Before Installation :

- Please flush all lines prior to installation of this valve
- This valve is designed as a way to direct water to one or two of three different functions, (e.g., showerhead, Hand shower, body sprays, tub spout, etc.) in addition to selecting 1 function with this diverter you can also select 2 functions at the same time and the water flow will be equally divided between those 2 functions please see Fig. 3 for a more detailed explanation
- A mixer valve is required to be used in conjunction with this valve, the mixer valve can be a conventional shower valve, Pressure balanced valve or thermostatic)
- Your mixer valve can serve as a shut-off valve or volume control valve, or as an option you may add an independent volume control valve.
- The bottom outlet on your mixer valve should be plug when being installed in conjunction with this diverter
- If you are going to be using a tub spout as part of your shower layout, plug the bottom outlet of your mixer valve and plumb the tub spout to one of the outlets on the 6 way diverter.
- If you are going to plumb only 2 functions out of the 6 way diverter, it is recommended that the outlet that is not in use be plumbed into the line of one of the other functions. (see Fig. 2)

Fig. 1

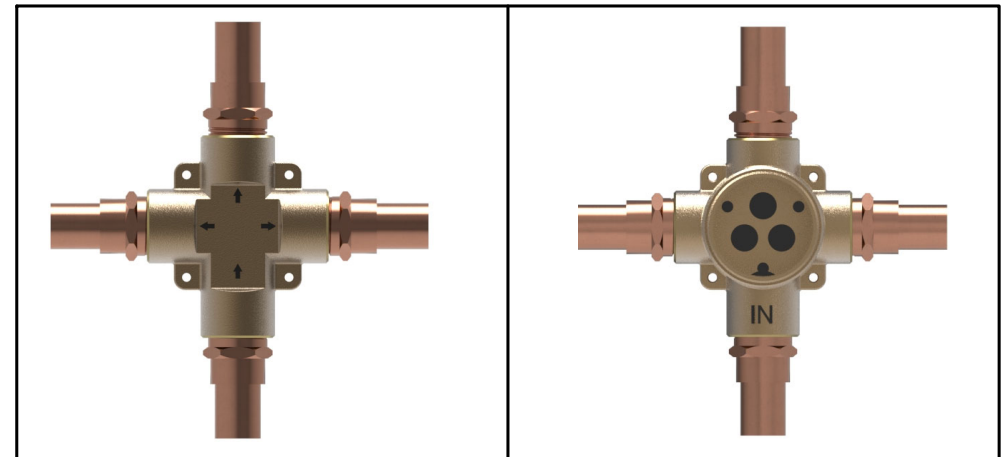
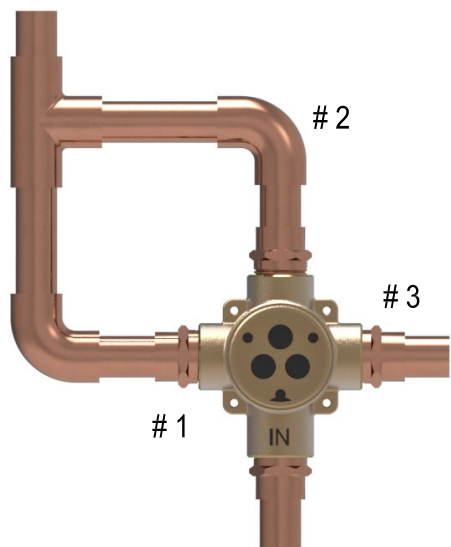
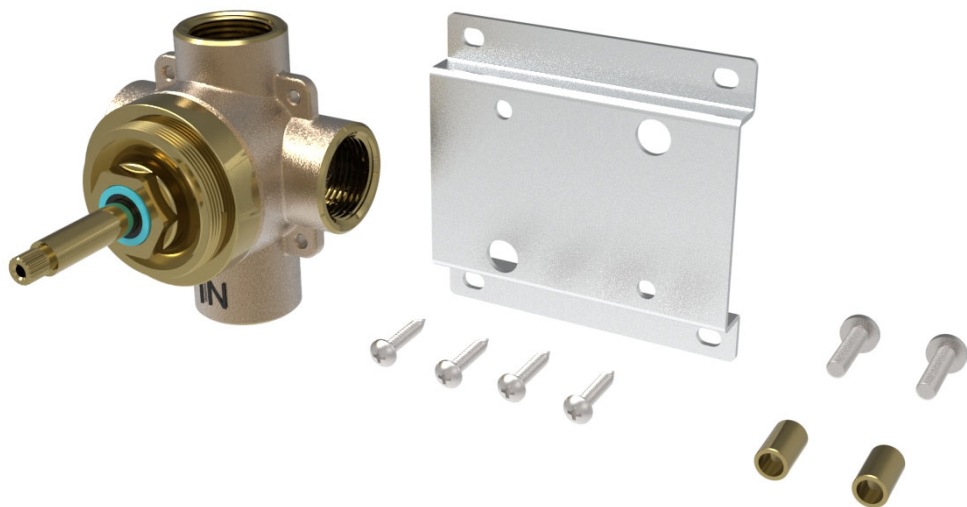

Fig. 2



Pressure Balancing Valve and Mounting Bracket:



Installation Step:

1. Flip the valve to the back side, pass screws through the sleeve, then secure the mounting bracket onto the valve. Use a screwdriver to tighten the screws.

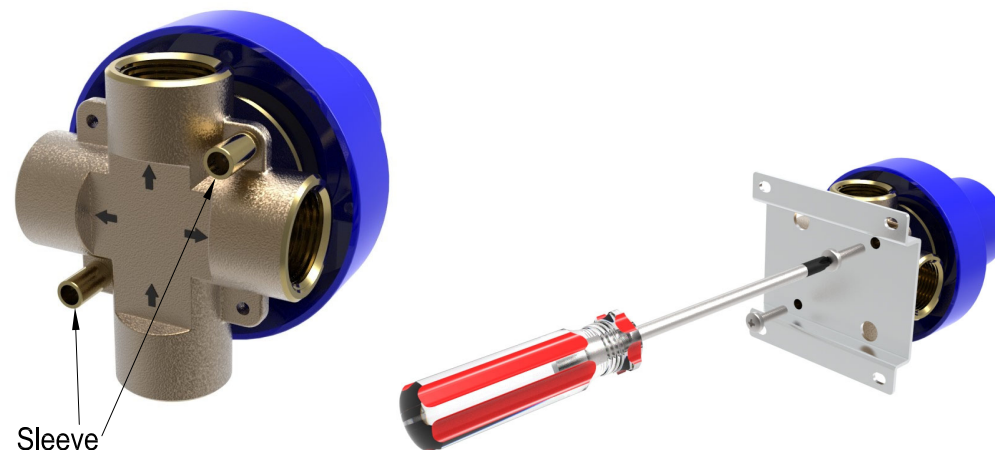

2. Apply Teflon tape or pipe thread sealer on all threaded connections.



3. Flip the valve back to the front side. Using the plastic plaster guard as a guide install the diverter valve so that the plaster guard will be flush with the finished wall or 1-3/4" from the centerline of the valve, locate the diverter valve at a convenient location above the mixer valve, make sure to identify the inlet by the arrow pointing towards the center of the diverter valve.

4. Connect the incoming line from the mixer valve to the inlet of the diverter, and plumb each outlet to its designated fixture.
5. Once the wall is finished, remove plaster guard and install the trim pieces by inserting the face plate on the valve and attaching handle.

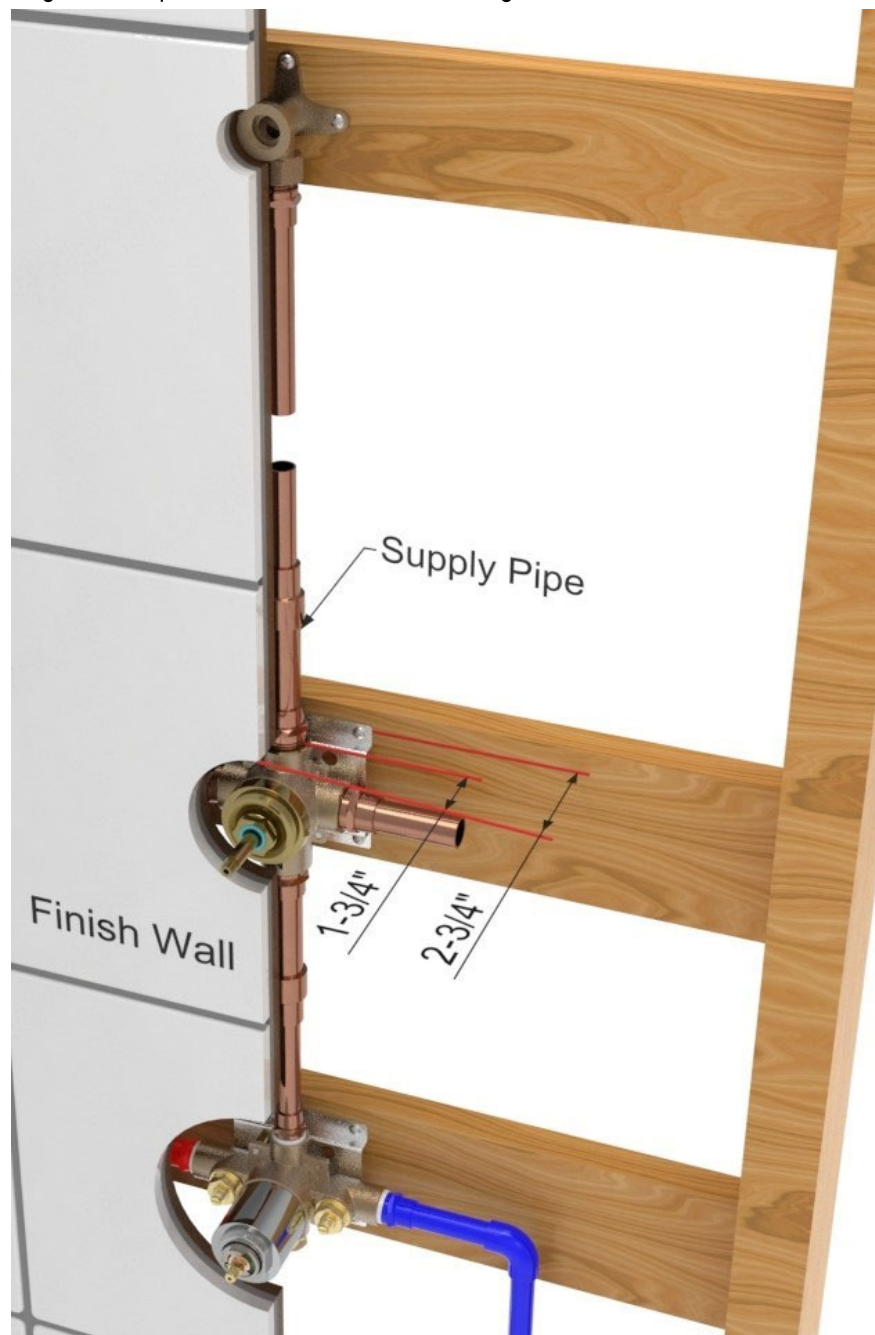

The 6 way diverter valve is designed to provide water flow to 2 functions at the same time, when you move the handle to a position in between 2 functions it will provide an equal amount of water flow to both of those functions.

