

Aqua Eden

ELEMENTS OF DISTINCTIVE STYLE

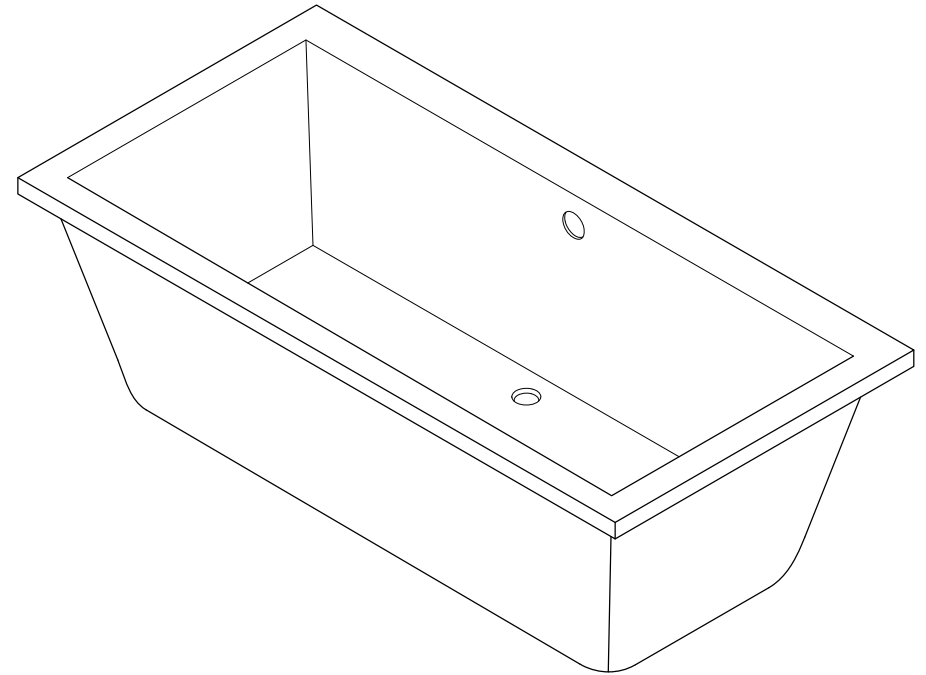

www.kingstonbrass.com
TOLL-FREE CUSTOMER SERVICE: 1-877-2-KBRASS
TECHNICAL SUPPORT E-mail: service@kingstonbrass.com
12775 Reservoir Street, Chino, CA 91710

NOTICE

Failure to follow all directions may cause leaks
which may result in water damage



WARNING

Lifting hazard.

Single person lift could
cause injury.
Use assistance when
moving or lifting.

Aqua Eden

ELEMENTS OF DISTINCTIVE STYLE

INSTALLATION INSTRUCTIONS Drop-in Tub with or without Drain

IMPORTANT

IT IS YOUR RESPONSIBILITY TO INSPECT THE TUB: Notices are printed on the shipping carton advising the recipient of this responsibility. The tub owner or installer is responsible to ensure the unit is free of defects and damage. If damage is noticed at time of delivery, this damage shall be brought to the delivery driver's attention and the delivery refused, specifying in writing on the bill of lading that the tub be damaged. In the event a problem exists, the unit must not be installed.

Kingston Brass is not responsible for defects or damage that could have been discovered, repaired, or avoided by inspection and testing prior to installation. The tub must be checked thoroughly within 48 hours of delivery, even if the tub will not be installed at this time. No claims for damages or blemishes will be accepted once the tub has been installed. Check that all parts are included.

If you have any missing parts, defects or damage is found or have any questions regarding the installation process, please contact Kingston Brass customer service at (877)-252-7277.

BEFORE YOU BEGIN INSTALLATION. Please read the following instructions, observe all local plumbing and building codes.

- Check area where tub will be installed to ensure that it is level and structurally sound.
- Store bathtub in a safe place until you begin installation to avoid damage to the tub's surface.
- We recommend that the installation of this tub be done by a qualified licensed professional.
- Because of its weight and volume we recommend that the installation of this tub be done with the help of at least one other person, a fall even what may seem like a minor one may result in cracking of the tub, moving straps and rubber gripped gloves are recommended.
- These Installation instructions do not include details of waste connections, the final details should be determined by your contractor.

INSTALLATION

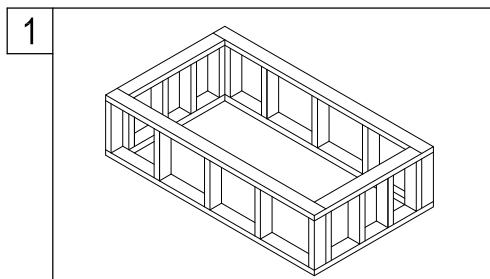

1. Build a recess deck to the specific measurements of your tub using 2" x 4" lumber.

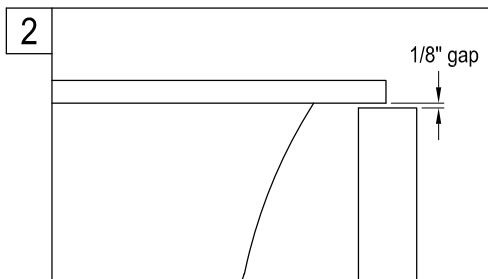

2. Because the specific type of waste installation is determined by the installer, the finish height of the deck will be the minimum height needed to connect the bathtub to the waste connection, measured from the floor to the bottom lip of the tub plus 1/8", the weight of the tub should not hang on the rim, make sure to allow for the thickness of the cement board underlayment as well as the tile or stone deck surface.

Need Tools:

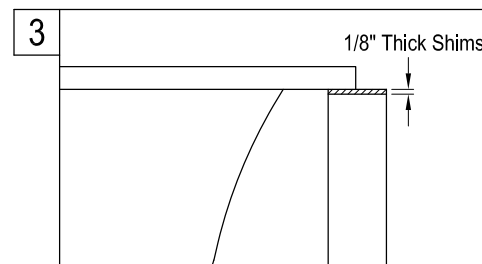
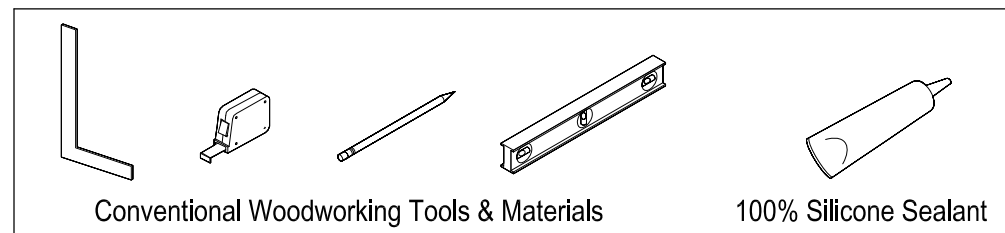

3. Make sure to leave an access area to be able to make the plumbing and drain connections once the tub is in place. Place 1/8" thick shims on top of the finished deck around the perimeter where the tub rim will make contact with the deck.

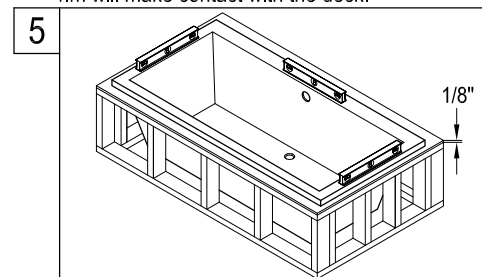

5. Set the tub on the mortar bed, making sure that the 1/8" thick shims are positioned around the perimeter of the tub and level the tub in all directions.

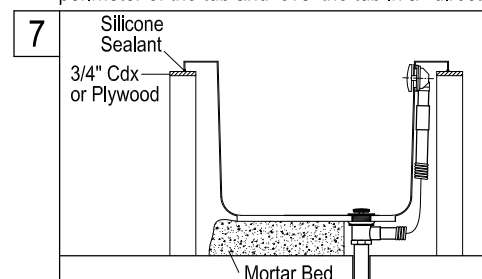

7. Connect to drain to the waste stub out and install faucet, fill the tub with water and check for leaks.

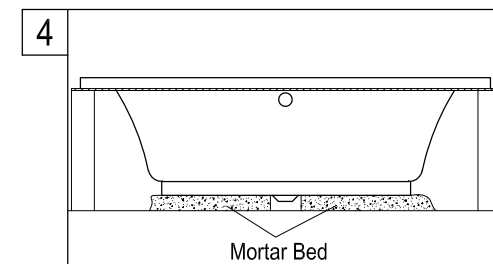

4. Pour a mortar bed under the area where the tub will be resting, except on the area around the drain, the mortar bed should be thick enough to provide ample support to the tub.

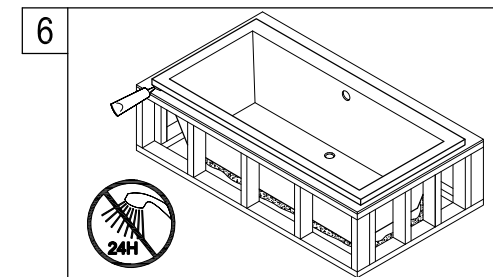

6. Let the mortar bed dry for at least 24 hours, check to make sure that all parts of the tub are adequately supported by the mortar bed, if necessary add mortar to the areas where the tub does not feel firmly supported, remove the shims and apply silicone caulking around the perimeter of the tub.

Cleaning

Clean with a damp cloth only.
Avoid using metal or abrasive polishes.