

# KB6330, 1, 2, 3, 6, 7, 8BX

Single Handle Pressure Balanced Tub & Shower Faucet

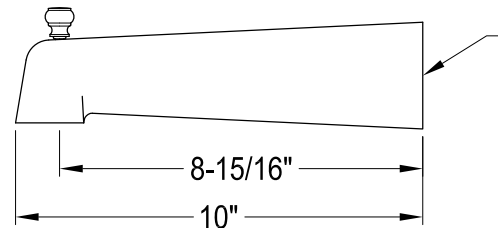
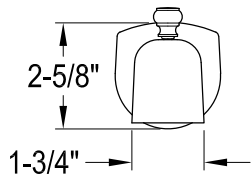
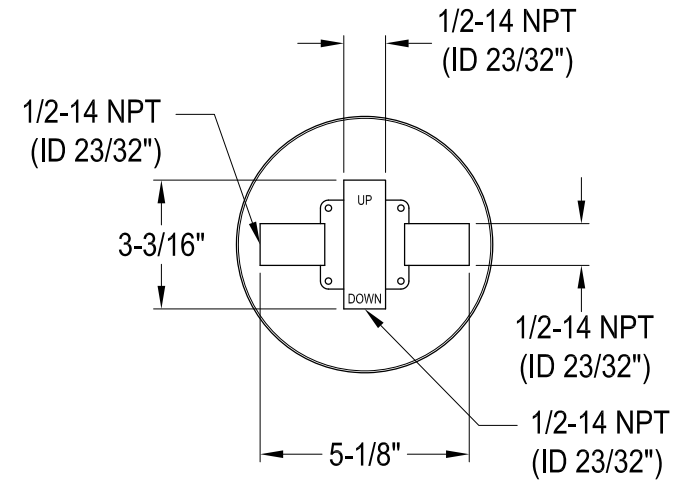
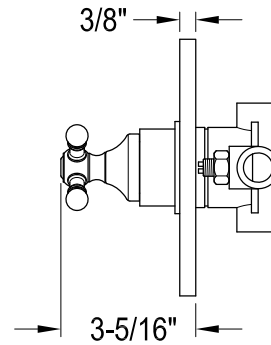
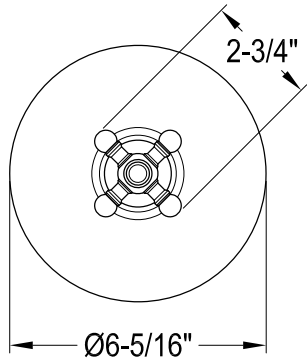
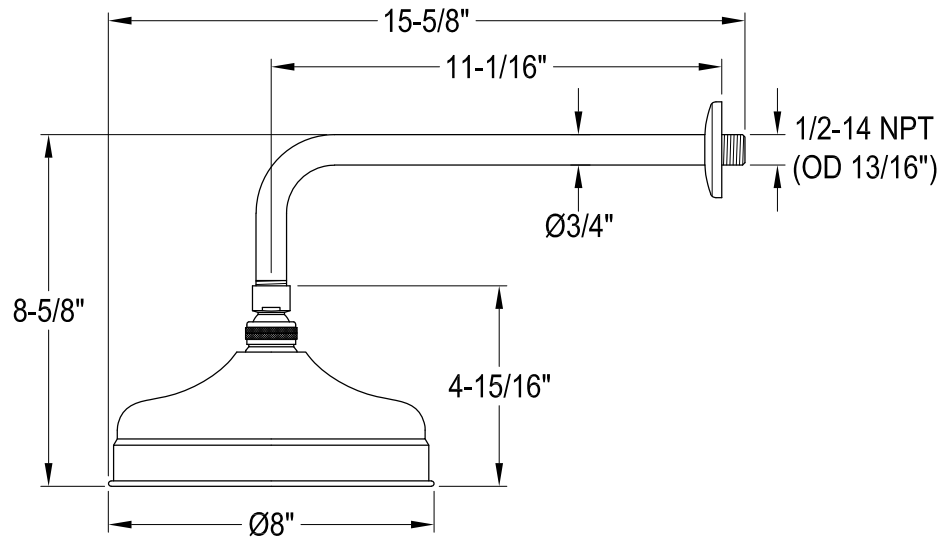
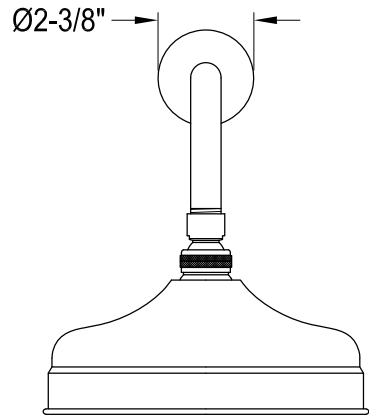

Fit 1/2" Copper Pipe (OD 5/8")  
or 1/2-14 NPT (ID 23/32")  
or 3/4-14 NPT (ID 15/16")